

HDZP30XD4

30x Zoom IR PTZ Dome Camera









HD

CAMERA	
VIDEO STANDARD	NTSC/PAL
SCANNING SYSTEM	Progressive scan
IMAGE SENSOR	1/3" 4 MP CMOS
NUMBER OF PIXELS (H x V)	2592x1520
MINIMUM ILLUMINATION	0.05 lux color @ F1.6, 0 lux B/W with IR LEDs on @ F1.6
S/N RATIO	> 55 dB
ELECTRONIC SHUTTER SPEED	1/3 – 1/300,000 s
RESOLUTION	4 MP (2592x1520)
IR DISTANCE	Up to 328 ft. (100 m), depending on scene reflectance
NUMBER OF IR LEDs	4 IR LEDs
DAY/NIGHT	Auto (ICR)/Color/B&W
BACKLIGHT COMPENSATION	BLC/HLC/WDR (120dB)
WHITE BALANCE	Auto/ATW/Indoor/Outdoor/Manual
GAIN CONTROL	Auto/Manual
WIDE DYNAMIC RANGE	DWDR
NOISE REDUCTION	Ultra DNR (2D/3D)
LENS	4.5 – 135 mm, MFZ, F1.6
HORIZONTAL ANGLE OF VIEW	60° ~ 2.2°
OPTICAL ZOOM	30x
DIGITAL ZOOM	16x
CLOSE FOCUS DISTANCE	100 mm – 1000 mm
FOCUS CONTROL	Auto/Manual
OPERATION	
PAN/TILT RANGE	Pan: 0°~360° endless; Tilt: 15°~90°
AUTO FLIP	180°
MANUAL CONTROL SPEED	Pan: 0.1°~300°/s; Tilt: 0.1°~200°/s
PRESET SPEED	Pan: 400°/s; Tilt: 200°/s
PRESETS	300
PTZ MODE	5 Pattern; 8 Tour; Auto Pan; Auto Scan
SPEED SETUP	Human-oriented focal length/speed adaptation
POWER UP ACTION	Auto restore to previous PTZ and lens status after power failure
PRIVACY MASKING	Up to 24 configurable areas
AUDIO	N/A

ELECTRICAL	
POWER SUPPLY	24 VAC/3A ±10%
AC FREQUENCY	50/60 Hz
POWER CONSUMPTION	1.3 W max. (2.3 W with IR LEDs on)
MECHANICAL	
DIMENSIONS	Ø7.3" x 12.2" (Ø 186.0 mm x 309.0 mm)
PRODUCT WEIGHT	7.7 lb. (3.5 kg)
PACKAGE WEIGHT	15.0 lb. (6.8 kg)
CONSTRUCTION	Die-cast Aluminum
CONSTRUCTION COLOR	RAL 9003 (White)
CONNECTIONS	
ALARM INPUT/OUTPUT	2/1
VIDEO OUTPUT	1-channel BNC high definition video output
VIDEO INTERFACE	1
AUDIO INTERFACE	1 channel in
RS-485	1
ENVIRONMENTAL	
OPERATING TEMPERATURE	-40°F to 158°F (-40°C to 70°C)
RELATIVE HUMIDITY	Less than 90% RH
INGRESS PROTECTION	IP66
IP SPECIFICATIONS	
PROTOCOL	Pelco-P/D (Auto recognition)
RESOLUTION	4 MP (2592x1520)/1080p(1920x1080)/720p(1280x720)
FRAME RATE	25/30 fps @ 4 MP/1080p; 25/30/50/60 fps @ 720p
REGULATORY	
EMISSIONS	EN55032, ANSI C63.4-2014
IMMUNITY	CE EN50130-4
SAFETY	UL60950-1; EN60950-1
ROHS	EN 50581

30x Zoom IR PTZ Dome Cameras

RECOMMENDED ACCESSORIES

SYSTEM COMPATIBILITY		HOUSING AND MOUNTS	
HRHT404* HQA DVRS	4 MP, 4-channel, 4 MP@15 fps, 1080p@30/25 fps, 1 SATA, Hybrid HQA DVRS	HDZPMA	 Pole Mount Adapter
HRHT408* HQA DVRS	4 MP, 8-channel, 4 MP@15 fps, 1080p@30/25 fps, 2 SATA, Hybrid HQA DVRS	HDZCMA	 Corner Mount Adapter
HRHT416* HQA DVRS	4 MP, 16-channel, 4 MP@15 fps, 1080p@30/25 fps, 2 SATA, Hybrid HQA DVRS	HDZGM	 Gooseneck Mount (Included with Camera with 1.5" MPT Adapter)
HRHQ104* HQA DVRS**	4-channel, 720p@120/100 fps, 1080p@60/50 fps, 1 SATA, alarm I/O, Hybrid HQA DVRS	HDZCM1	 PTZ Ceiling Mount
HRHQ108* HQA DVRS**	8-channel, 720p@240/200 fps, 1080p@120/100 fps, 2 SATA, alarm I/O, Hybrid HQA DVRS	HDZJB	 Junction Box
HRHQ116* HQA DVRS**	16-channel, 720p@480/400 fps, 1080p@240/200 fps, 2 SATA, alarm I/O, Hybrid HQA DVRS	HDZBSPA	 1.5" MPT Mount Adapter

* Pre-installed storage (TB).

** Change the HDZP30XDP4 video output to 1080p before using it with HRHQ DVRS.

ORDERING

HDZP30XDP4	TDN IR PTZ Dome Camera, 4 MP Resolution, 30x Zoom, 1/3" 4 MP CMOS, 4.5-135 mm Lens, 4 IR LEDs, 24 VAC, IP66
------------	---

DIMENSIONS

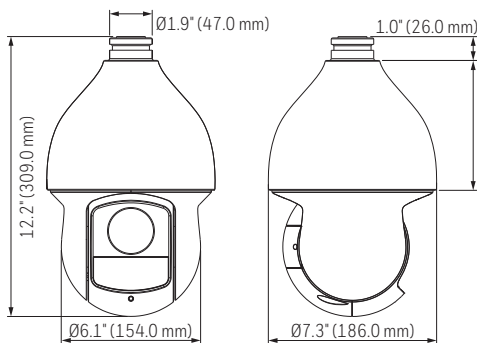

For more information

www.honeywell.com/security

Honeywell Security and Fire

2700 Blankenbaker Pkwy, Suite 150
 Louisville, KY 40299
 1.800.323.4576
www.honeywell.com

Honeywell reserves the right, without notification, to make changes in product design or specifications.

L/HDZP30XD4D/D | 10/17
 © 2017 Honeywell International Inc.

Honeywell