

**Honeywell**

# TR80

WALL MODULE



---

## Installation and Operating Guide

---

# Disclaimer

This document contains Honeywell proprietary information. Information contained herein is to be used solely for the purpose submitted, and no part of this document or its contents shall be reproduced, published, or disclosed to a third party without the express permission of Honeywell International Inc.

While this information is presented in good faith and believed to be accurate, Honeywell disclaims the implied warranties of merchantability and fitness for a purpose and makes no express warranties except as may be stated in its written agreement with and for its customer.

In no event is Honeywell liable to anyone for any direct, special, or consequential damages. The information and specifications in this document are subject to change without notice.

© 2021 – Honeywell International Inc.

# Other Trademarks

Third-party brands and names are the property of their respective owners.

Microsoft®, Win32, Windows®, Windows XP, Windows Vista, Windows 7, Windows 8, Visual Studio are either registered trademarks or trademarks of the Microsoft Corporation in the United States and other countries. Other products and company names mentioned herein may be the trademarks of their respective owners.

The example companies, organizations, products, domain names, e-mail addresses, logo, people, places, and events depicted herein are fictitious. No association with any real company, organization, product, domain name, e-mail address, logo, person, place or event is intended or should be inferred.

# Support and Other Contacts

For technical assistance or further information, call your nearest Honeywell office.

# Revisions

<b>Document Version</b>	<b>Firmware Version</b>	<b>Published</b>	<b>Changes</b>	<b>Comment</b>
09-21	1.2.1.0	08-07-21	Whole document	New document

# TABLE OF CONTENT

<b>CHAPTER 1 - INTRODUCTION TO TR80 .....</b>	<b>1</b>
Introduction.....	1
Dimensions.....	2
Installing the TR80 Wall Module.....	2
Before Installation .....	2
Steps to install TR80 Wall module:.....	3
Wiring Connections .....	6
Wiring Terminals.....	7
Powering Up the Wall Module .....	7
TR80 LCD Display.....	8
User Interface .....	11
LED Ring Behavior .....	12
Specification .....	13
System Architecture .....	14
<b>CHAPTER 2 - OPERATIONS.....</b>	<b>19</b>
Overview of Device States .....	19
Access Level .....	20
Activating The Screen.....	20
Unlocking The Device .....	21
Entering The Pin.....	21
Monitoring Current Status and Values .....	21
Adjusting Temperature.....	22
Changing The Temperature Unit .....	22

Adjusting The Fan Speed .....	23
Multi Speed Fans .....	23
EC Fans .....	24
Selecting Or Overriding Occupancy status .....	24
Simple Occupied/ unoccupied selection .....	24
Advanced Occupied/ unoccupied selection .....	25
Overriding the occupancy mode.....	26
Selecting / Overriding HVAC mode.....	26
Selecting ECO operation .....	27
Controlling Lights .....	27
Basic on/off control .....	28
Basic dimming control .....	28
On/off control with scene selection .....	29
Dimming control with scene selection.....	29
Controlling Blinds .....	30
DO-NOT-DISTURB / MAKE-UP-ROOM .....	30
Cleaning The Front Glass.....	31

## **CHAPTER 3 - CONFIGURATION OF TR80 ..... 32**

INTRODUCTION .....	32
Entering the configuration mode .....	32
Temporary Commissioning Mode .....	33
Factory Reset .....	33
DEVICE .....	33
Save Changes .....	33
Device Information .....	34
Config identification.....	34
COMMUNICATION .....	35
Port 1 configuration .....	35
Port 2 configuration .....	35
GENERAL MONITORING REGISTERS.....	36
Fault Conditions .....	36
Override Status and Reset.....	36

What has changed.....	37
Active Display Mode.....	37
SENSORS & EXTERNAL INPUT.....	38
Configuration.....	38
Monitoring.....	38
DO-NOT-DISTURB & MAKE-UP-ROOM.....	39
CLEANING MODE.....	39
USER INTERFACE.....	39
Backlight Brightness.....	39
LED Ring.....	40
Temperature display configuration.....	40
LCD Symbols.....	41
Text override.....	41
Power button functions.....	42
User access control and timeouts.....	43
HVAC.....	44
Temperature setting.....	44
Fan Speed Control.....	45
HVAC mode selection.....	46
OCCUPANCY.....	47
Occupancy source.....	47
Occupancy control.....	48
Holiday & Bypass overrides.....	49
Allowed User Overrides.....	49
Auto-reset of occupancy override.....	50
LIGHTING CONTROL.....	50
Light Group 1 configuration.....	51
Light Group 1 control.....	51
Light Group 2 configuration & control.....	52
Light Group 3 configuration & control.....	52
Light Group 4 configuration & control.....	53
Scene definitions for Power Button.....	53
BLINDS CONTROL.....	54
Blind Group 1 configuration parameters.....	54

Blind Group 1 control parameters.....	55
Blind Group2 Configuration & Control Parameters .....	55
DISPLAY VALUES.....	56
Room Temperature and Humidity Override .....	56
Pre-configured Display Parameters .....	56
Custom User Defined Parameter Unit.....	57
Display Values Configuration .....	58

**CHAPTER A - TROUBLESHOOTING ..... 60**

**CHAPTER B - CONFIGURATION PARAMETERS ..... 61**

List of Device configuration parameters.....	61
List of UI and Access configuration parameters.....	63
List of HVAC Configuration Parameters.....	65
List of Lighting Configuration Parameters.....	66
List of Blinds configuration Parameters .....	68
List of Occupancy configuration Parameters .....	69
List of Display Values configuration parameters.....	70

# INTRODUCTION TO TR80

## 1.1 Introduction

The Honeywell TR80 wall module delivers superior convenience, comfort, and energy management. Honeywell TR80 wall module includes onboard Sensors to display precise temperature and humidity measurements. It also offers an integrated HVAC Display, Light, and Blind controls.

Available in classy black and white color offering to replace the clutter on your wall which provides one unified room control and delightful user experience. The user-friendly intuitive display and dedicated 10 capacitive touch keys of the device help to achieve the perfect balance between Energy Efficiency and Comfort. TR80 is an advanced, configurable, connected device with its open industry-standard Modbus communication protocol that allows easy integration with several intelligent building controllers in diverse configurations.

Designed with human experience in mind, it offers ease of operation to occupants or guests with dedicated touch keys for Fan, Temperature, Lights, Blinds, Do Not Disturb, and Clean my Room. TR80 also displays indoor air quality parameters like CO<sub>2</sub>, TVOC, PM<sub>2.5</sub>, PM<sub>10</sub>, Air Flow, and Room Pressure through external sensors. Easy to disinfect and clean bezel-less glass front panel ensures user's safety and hygiene.





## 1.2 Dimensions

TR 80 wall module dimensions are as shown below:

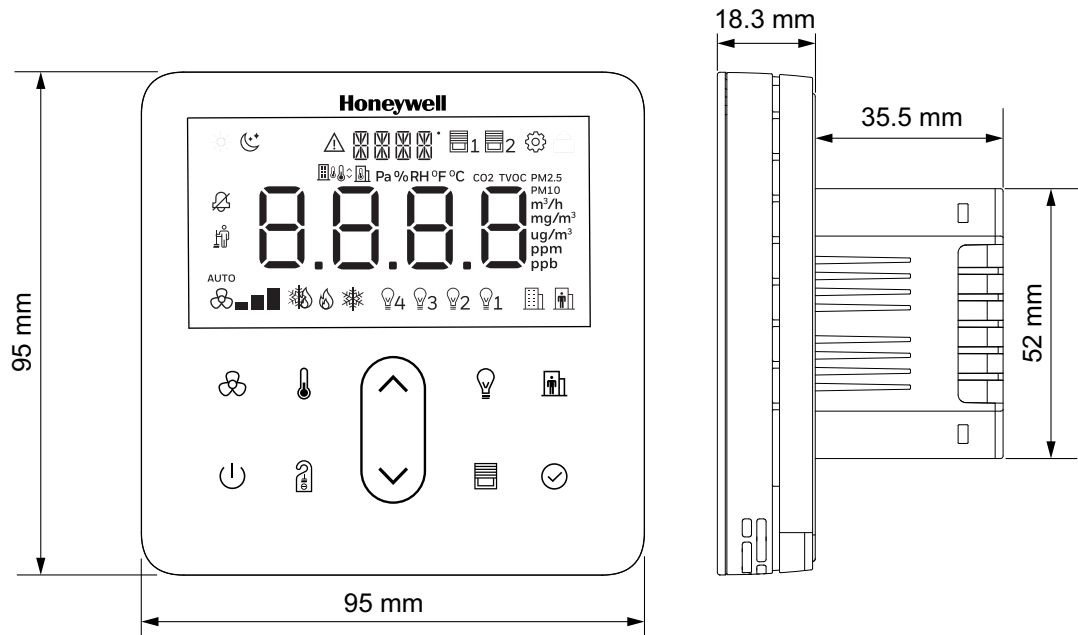

## 1.3 Installing the TR80 Wall Module

### 1.3.1 Before Installation

1. Read these instructions carefully. Failure to follow them could damage the product or cause a hazardous condition.
2. Check the ratings given in the instructions and on the product to make sure the product is suitable for your application. The Installer must be a trained, experienced service technician.
3. After installation is complete, check out product operation as provided in these instructions.

**Note:** All wiring must agree with applicable codes, ordinances and regulations or as specified on installation wiring diagrams.

**Caution: Improper use can create dangerous situations.**



For life-safety applications, this device can function only as a secondary or lesser device.



**Caution: Electrical Shock or Equipment Damage Hazard. Can shock individuals or short equipment circuitry.**

Disconnect power supply before Installation.



**Caution: Equipment Damage Hazard. Electrostatic discharge can short equipment circuitry.**

Ensure that you are properly grounded before handling the unit.

### 1.3.2 Steps to install TR80 Wall module:

1. Switch OFF the power supply before initiating the TR80 installation.

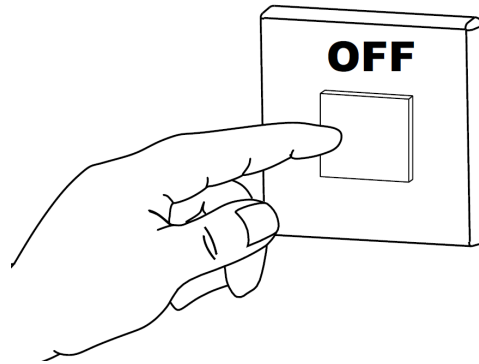

2. Loosen the bottom screw a few turns.

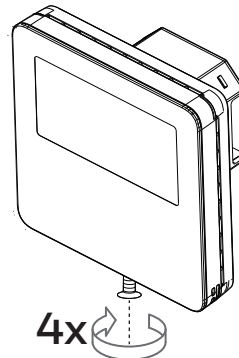

3. Separate front panel and base by pulling out from the bottom, to do the wiring.

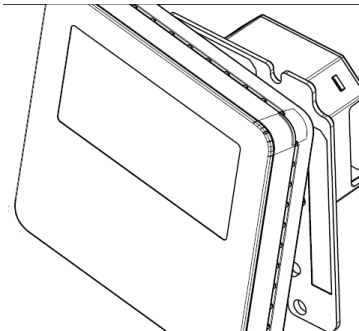

4. Pull the power cable and communication cables through the wall box.

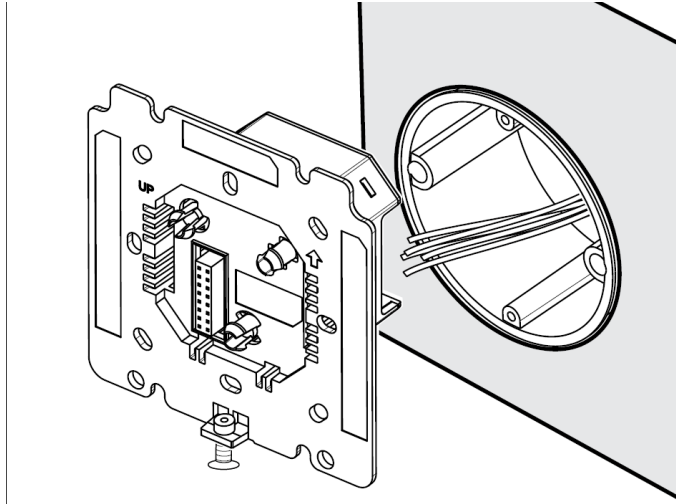

5. Connect the wires well according to the wiring diagram. Refer to wiring details.

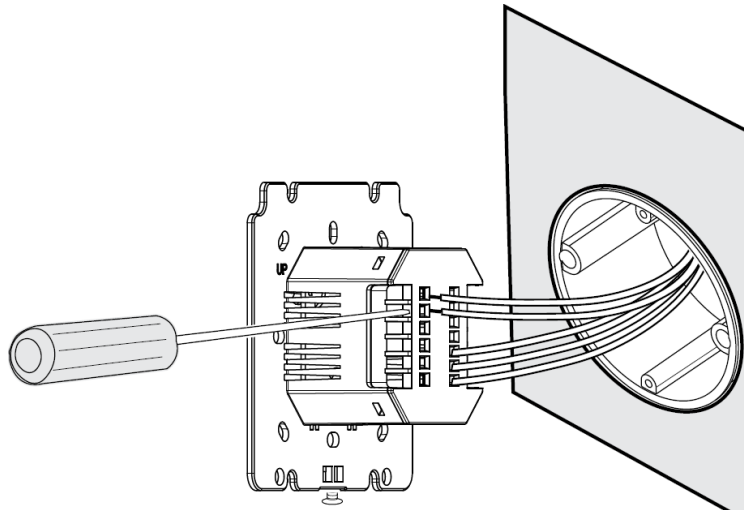

6. Fix the base with 2 screws to the wall box.

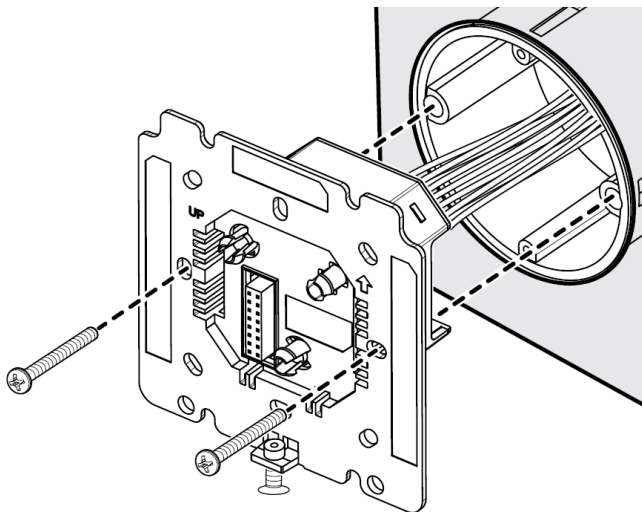

7. Attach front panel to the base.

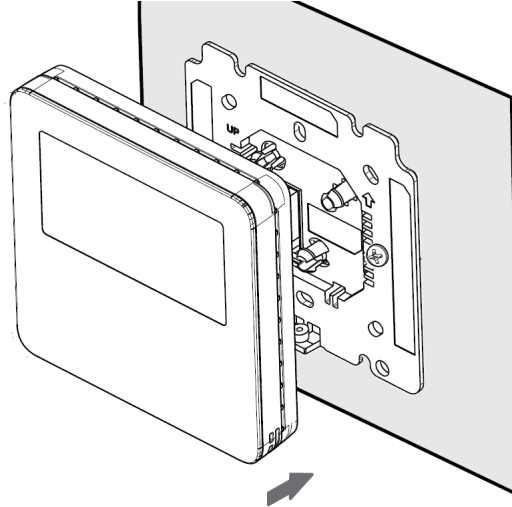

8. Tighten the bottom screw, to fix front panel and base.

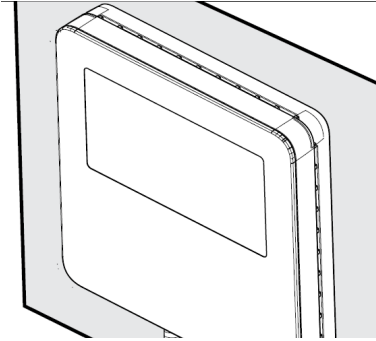

9. Switch ON the power supply to start the TR80 wall module.

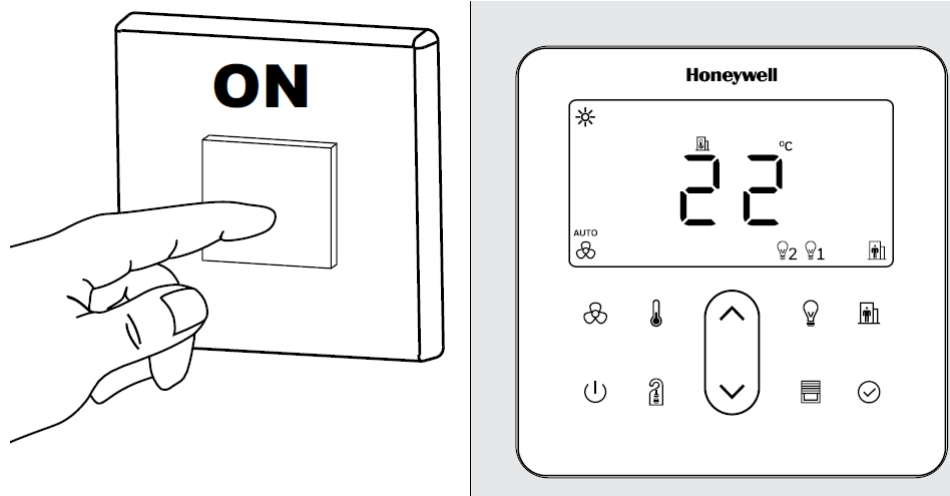

### 1.3.3 Wiring Connections

Wiring diagram for 24V AC/DC and 100 - 230V AC Power Supply are shown below.



**Caution: Electrical Shock or Equipment Damage Hazard.**

Can shock individuals or short equipment circuitry.

Disconnect power supply before Installation.

All wiring must comply with local electrical codes and ordinances or as per below wiring connections.

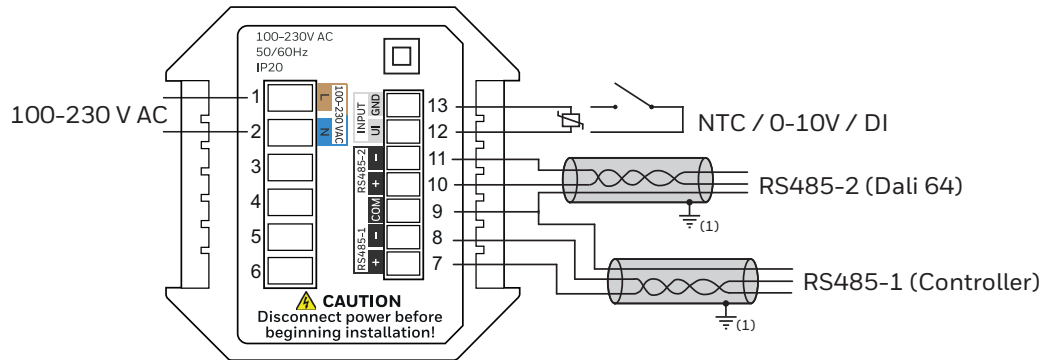
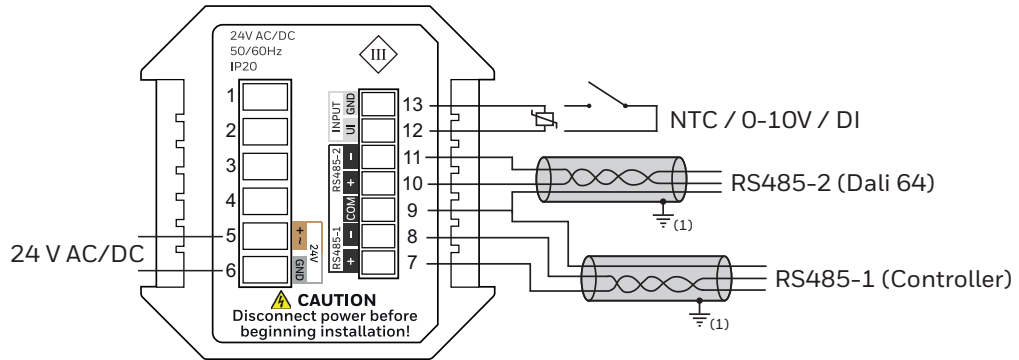

(1) Shield should be connected to earth ground at one end only.

### 1.3.3.1 Wiring Terminals

Terminals Number	Legends	Description
1	L	100 to 230 V AC, 50/60 Hz Power supply connection
2	N	
5	+ ~	24 Vac/dc $\pm$ 10% Power supply connection
6	GND	
7	+	RS485 Port 1 Modbus RTU slave connection to controller
8	-	
9	COM	Shared common for port1 & port 2
10	+	RS485 Port 2 Modbus RTU repeater connection to DALI64
11	-	
12	UI	General purpose universal input for NTC10K, NTC20K, 0-10 Vdc & voltage free contact
13	GND	

### 1.3.4 Powering Up the Wall Module

Once the wall module is installed and powered, the unit gets started shows firm-ware version number and goes through the startup sequence to display the ready or protected mode.





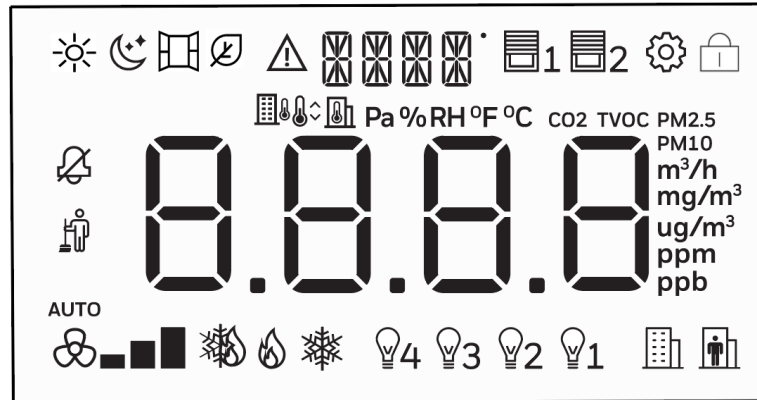







# 1.4 TR80 LCD Display

The LCD of TR80 wall module with all possible segments is as shown below:



The following table provide an overview of all available segments of the TR80 wall module with its defined name.

Name	Segment	Description
Day		Day symbol
Night		Night symbol
Window open symbol		Indicates that a window is open.A/C may be automatically turned off..
Eco Mode		Indicates system is in an energy-saving state.
Alarm Symbol		Indicates that an alarm or fault condition exists.
Secondary Display		Used to show a short text depending on the semantic meaning of a display value , mode etc.
Blind / shutter/ curtain symbol		Active when setting position or angle for the particular group.
Configuration		Indicates device is in configuration mode.
Lock		Indicates that device is in locked state, restricting value changes. A key combination or PinPin entry will be needed to unlock it.

Name	Segment	Description
Outdoor Value, Indoor Value and Set value		Indicates displayed value is related to outdoor conditions .
		Indicates displayed value is relates to indoor (room) conditions
		Indicates set-point value is displayed.
Fan and Fan speed		Fan symbol
		Fan speed symbol
	<b>AUTO</b>	Indicates fan speed is in auto mode
HVAC Mode		Heating mode
		Cooling mode
		Auto mode
Lighting groups		Up-to four lighting groups are supported by TR80 wall module. Indicates if the group is ON or OFF, in setting mode indicates selected group.
Unoccupied symbol and occupied symbol		Indicates device is in unoccupied state.
		Active when device is in occupancy state.
Main Display		The main display is primarily used to show system parameter values.









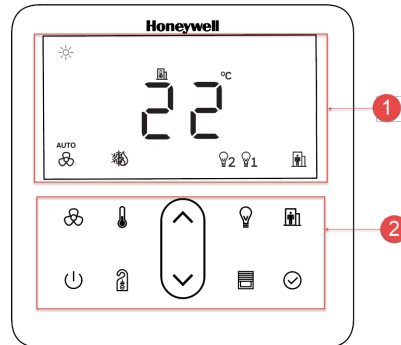



Name	Segment	Description
Unit symbols	<b>Pa</b>	Pascal
	<b>%</b>	Percentage
	<b>RH</b>	Relative Humidity
	<b>°C</b>	Degree Celsius
	<b>°F</b>	Degree Fahrenheit
	<b>m<sup>3</sup>/h</b>	Meter Cube per hour
	<b>ug/m<sup>3</sup></b>	Micro gram per meter cube.
	<b>ppm</b>	Parts Per Million
	<b>ppb</b>	Parts Per Billion
	<b>mg/m<sup>3</sup></b>	unit for Total Volatile Organic compound (TVOC) measurement.
Indoor Air Quality Parameters	<b>CO2</b>	Carbon dioxide
	<b>TVOC</b>	Total Volatile Organic compound
	<b>PM2.5</b>	Particulate Matter 2.5
	<b>PM10</b>	Particulate Matter 10

# 1.5 User Interface

The TR80 user interface consist of **1** multi segment display and **2** 10 capacitive touch keys.



The following table provides the information of functionality associated with each key on the keypad.

Key symbol	Name	Description
	Fan key	Used to change the fan speed and mode.
	Temperature key	Short press to change temp. unit.  When HVAC mode selection is enabled: <ul style="list-style-type: none"> <li>• Short press to select HVAC mode.</li> <li>• Long press to change temp. unit.</li> </ul>
	Up/Down keys	Used to increment or decrement the set value.
	Light Key	Used to select lighting groups
	Occupancy Key	used to select or override occupancy status.
	Power Key	Power Key can be configured for various functions, Refer <a href="#">Power button functions</a> for more details.
	DnD/MuR key	Selects Do-Not-Disturb or Make-Up-Room indications.
	Blind key	Used to select the blinds.
	OK key	OK key serves different purposes depending on current mode.
	LED Ring	Show the active HVAC mode.

## 1.5.1 LED Ring Behavior

The LED ring color changes according to the active HVAC mode in the controller. The installer can configure the LED ring behavior as per the controller programming. The LED ring color and indicated mode for typical application is as shown in below table.

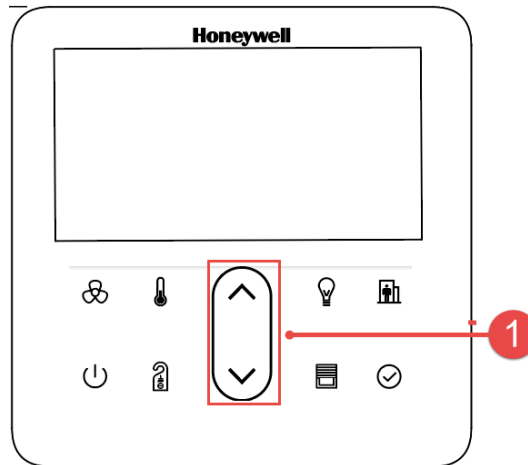

LED ring color	Description
Grey	Heating and cooling not available
Blue	System is in cooling Mode
Orange	System in heating mode
Purple	Both heating and cooling active
Green	System in fan-only or off mode
Red	Error condition

The LED ring is steady on when there is no active heating or cooling. When any heating or cooling source is active (e.g. valves open), the LED ring will be in 'breathing'. The breath frequency is related to active heating or cooling level.

## 1.6 Specification

<b>Weight and Dimensions</b>	
Dimension	L 95mm X W 95mm X D 54mm
Weight	256 grams
Minimum depth of wall box	47 mm
<b>Display</b>	
Display Type	Custom multi-segment LCD 72 x 37 mm
Buttons	10 integrated capacitive touch areas
Backlight	LED
Fascia	Tempered glass
<b>Operating Environment</b>	
Ambient operation temperature	0 to +50°C (32 to 122 °F)
Ambient Operating Humidity	5% to 95% relative humidity (non-condensing)
Storage Temperature	-30 to 65°C (-22 to 149 °F)
<b>Electrical</b>	
Power Supply	Version 1: 24Vac/dc ± 10%, Version 2: 100-230 VAC 50/60Hz
Power Consumption (Display ON)	Max 1.1 W for 24Vac/dc supply Max 4.5 W for 230V supply
Terminal Size	Power Supply: Upto 16 AWG or 1.5 mm <sup>2</sup> Modbus: Up to 17 AWG or 1mm <sup>2</sup>
<b>Communication</b>	
Modbus	RS485- 1: Modbus RTU Slave for controller RS485- 2: Modbus RTU Master for DALI 64.Sensor
Baud Rate	1200/2400/4800/9600/14400/19200/38400
<b>Sensor and Input</b>	
Temperature setting range	10 to 32°C (50 to 89.6°F)
External sensor inputs (Accuracy 1% of full scale)	NTC 10K - NTC20K - 0-10Vdc - Voltage-free contact
On-board Temperature sensor accuracy*	± 0.2 °C
On-board Humidity sensor accuracy*	±3% RH from 20-80%RH
*at 25 °C	
<b>Other Specification</b>	
IP Rating	IP20
Terminal Connections	Rising cage clamp, Screw terminal
Standard and Compliance	CE UKCA RoHS
Material of Casing	Flame retardant Polycarbonate (PC)

# 1.7 System Architecture

TR 80 wall module can act as Slave or Master in the Modbus communication network. The various example of system architecture are as shown below:

## System Architecture 1( TR80 and DALI as Modbus Slave to Room controller )

In this Architecture the controller act as Modbus Master for TR80 (Modbus slave) and DALI64(Modbus slave). User light commands are periodically polled from TR80 by controller and Transmitted to DALI64 for execution. The controller also regularly checks the light status/level from DALI64 periodically and updates the TR80 registers with current status. The Shutter/Blind User commands(level and/or Angle) is polled from TR80 by controller and executed via digital outputs.

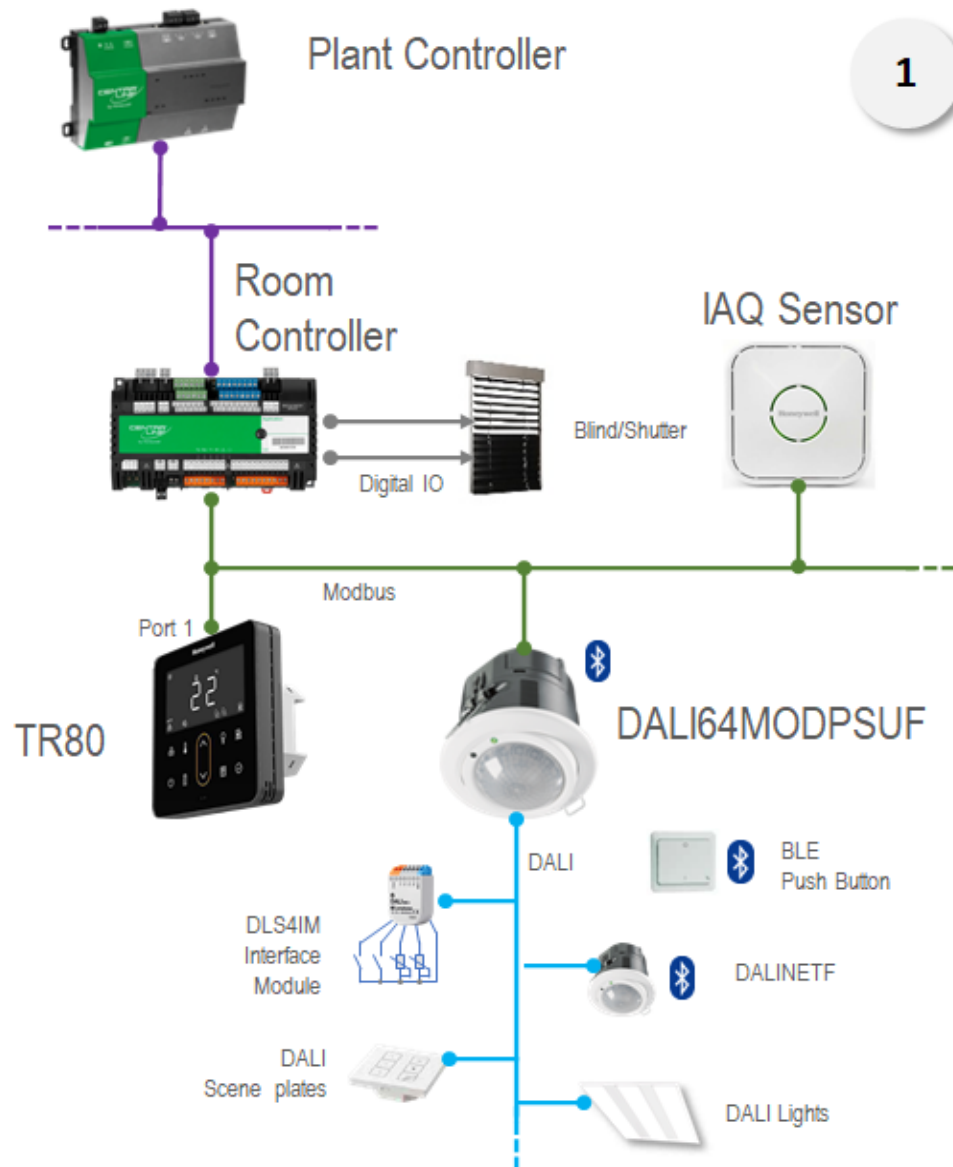

## System Architecture 2 (TR80 Modbus Slave to Room controller on Port 1 and DALI as Modbus Slave to TR80 on Port 2 (Direct Light Control).)

In this Architecture the controller act as Modbus Master for TR80 (Modbus slave). DALI 64(Modbus slave) is connected on Port 2 of the TR80(Modbus Master for DALI64). User light commands from TR80 are directly executed through DALI64 connected on Port 2 of TR80 and new status is also updated automatically by TR80 without any intervention required from controller. The TR80 also act as repeater for direct commands from controller to DALI64. Hence it is possible for controller(as Modbus Master) to poll DALI through TR80 as repeater and execute any light commands on DALI64. However in case of direct command from controller, the controller also need to read the light status form DALI64 and update the TR80 registers. The Shutter/Blind User commands(level and/or Angle) are polled from TR80 are polled by controller and executed via digital outputs.

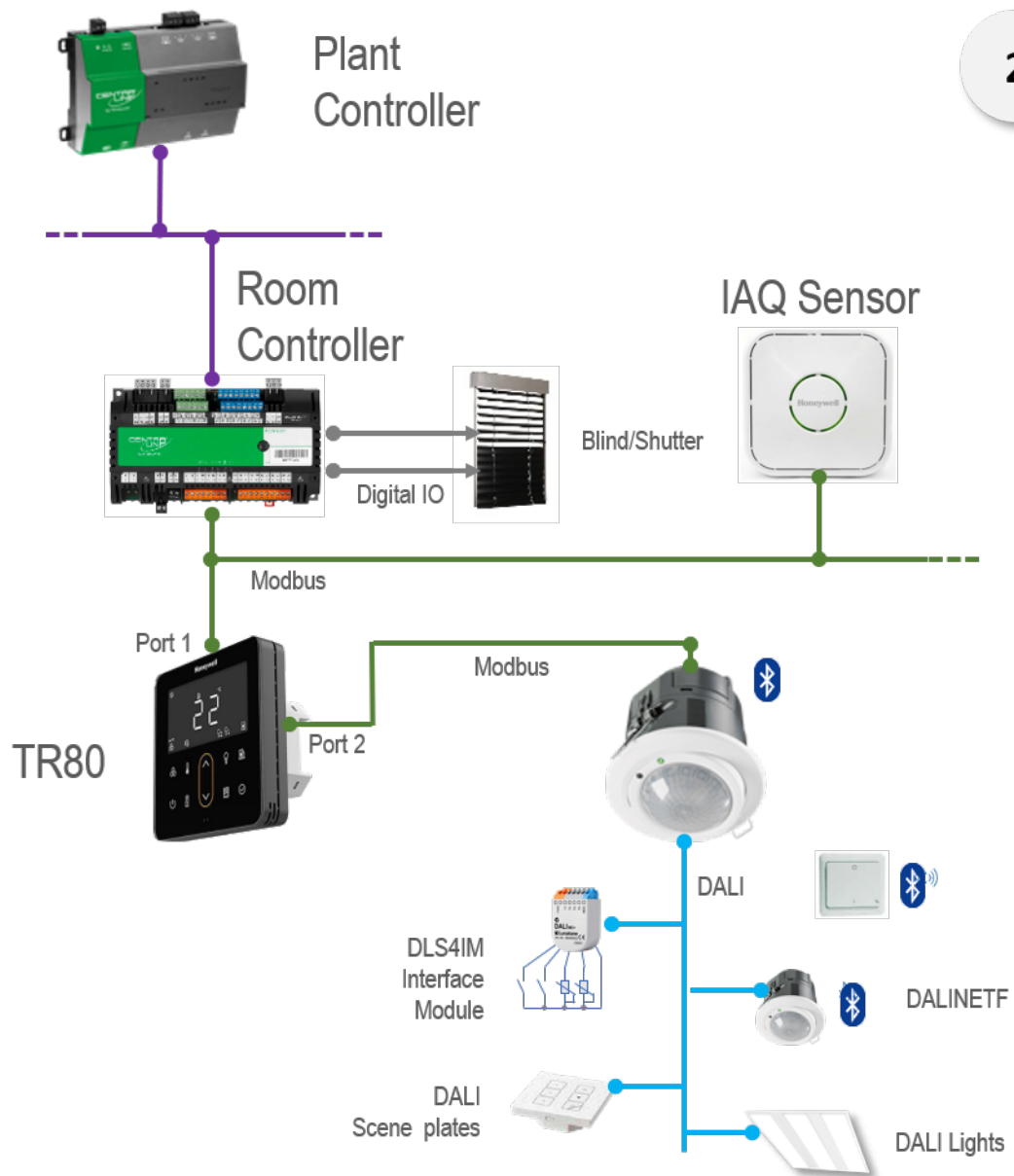

### System Architecture 3 (TR80 Modbus Slave to Room controller and DALI64 on Sylk bus connected to Room Controller)

In this Architecture the controller act as Modbus Master for TR80(Modbus slave). DALI 64 is connected on Sylk port of the controller. User light commands are polled from TR80 by controller and Transmitted to DALI64 over sylk bus for execution. The controller also regular checks the light status/level from DALI64 periodically on sylk bus and updates the TR80 registers with current status. The Shutter/Blind User commands(level and/or Angle) are polled from TR80 are polled by controller and executed via digital outputs.

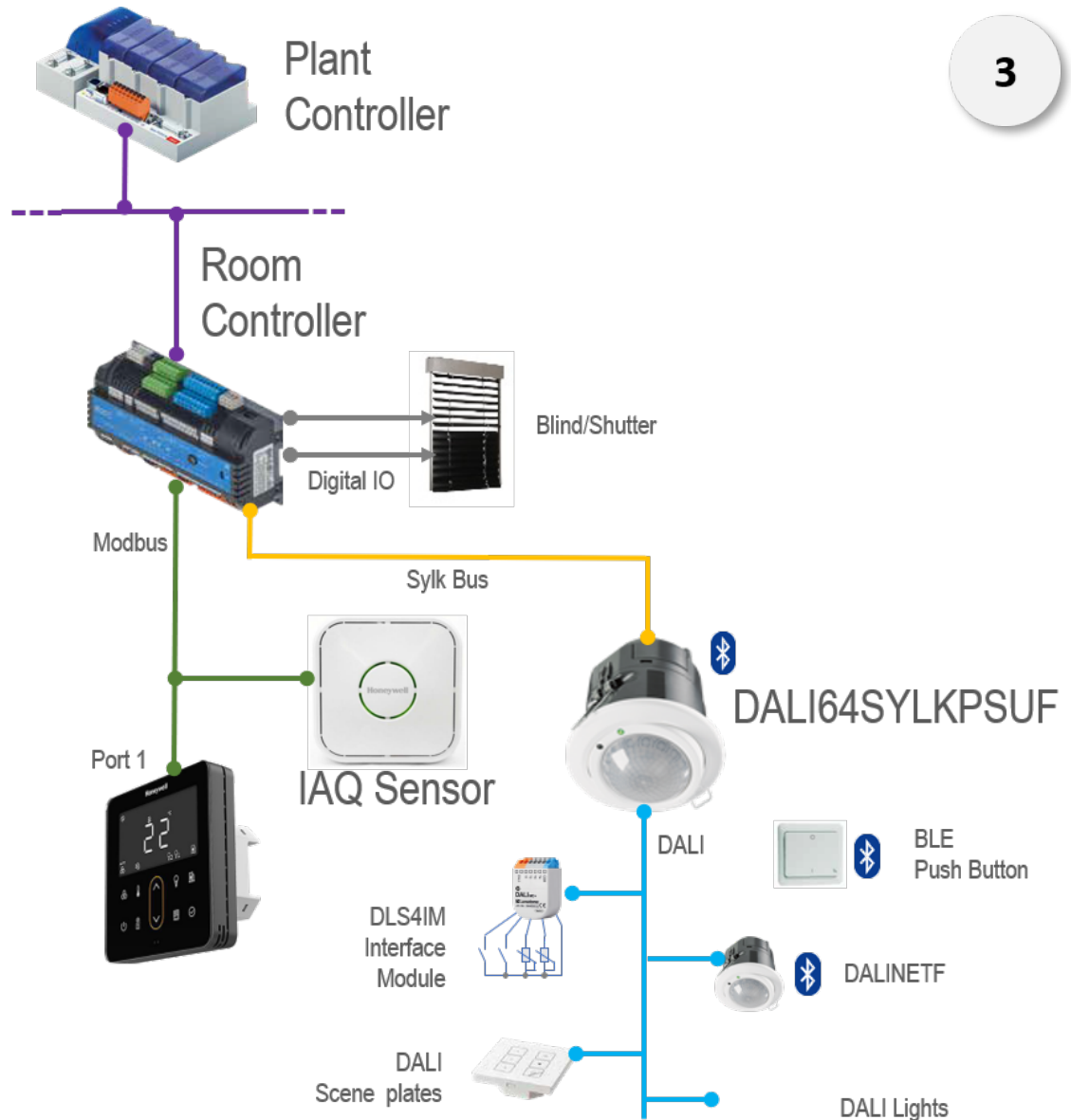

3

## System Architecture 4 (TR80 Modbus Slave to Room controller and conventional lighting on controller inputs/outputs.)

In this Architecture the controller act as Modbus Master for TR80(Modbus slave) and light and switches are connected on conventional digital and analogue Inputs/outputs of the controller. User light commands are polled from TR80 by controller and executed through digital and analogue outputs of the controller. The Shutter/Blind User commands(level and/or Angle) are polled from TR80 by controller and executed via digital outputs.

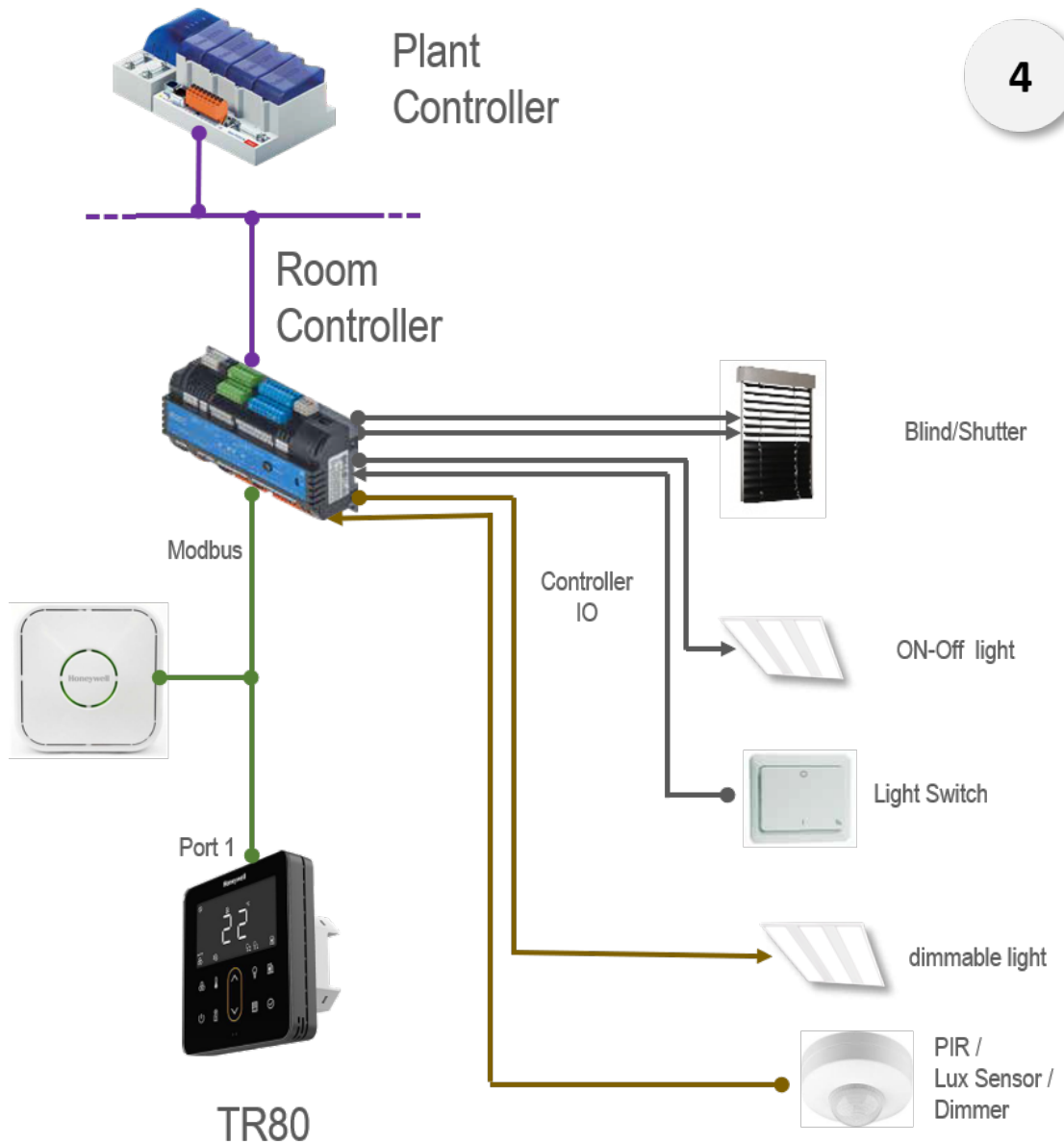

**Note:** Max recommended TR80 per room controller : 2 Nos  
 Max recommended TR80 per plant controller: 10-12 Nos  
 We may expend this limit going forward based on future testing



The various controllers suitable for various architecture is explained below:

<b>System Architecture</b>	<b>Room Controller</b>	<b>Plant Controller</b>
1	Merlin NX, IRM NX	EHNX, JACE 8000/ HAWK 8000
2	Merlin NX, IRM NX	EHNX, JACE 8000/ HAWK 8000
3	PCD7.LRXX-P5	PCD1/2/3
4	Modbus Room Controller	Supported Plant Controller



This chapter gives information about the operation that users can perform once the device is ready to use.

## 2.1 Overview of Device States



TR80 Display will switch between different states with user actions, or automatically on predefined timeouts.

Depending on the configuration, some states may be disabled entirely, or have restricted access requiring a key-combination or Pin entry.

The various available states are as follows:

- **Sleep**  
Display and button back-lights are OFF. LED ring remains ON or OFF depending on the configuration.
- **Display Only (Locked)**  
In this state, the user can monitor room temperature, setpoint, and other available current values. No changes or commands are allowed. Display shows  (lock) icon.
- **Operational state**  
In this state, the user can monitor current status and values. Additionally user can change HVAC setpoint, control lights and blinds but cannot do any changes to configuration.
- **Setup/Configuration**  
This state is available only for the installer. In this state, installer can perform the configuration of various parameters, by following the specific installation procedure or as per the user preferences.  
Display shows  Setting icon on the screen. To access this mode user need to enter four digit pin.

- **Cleaning**

Long press  and  to enter in cleaning mode. This mode prevents accidental activation of functions while wiping the glass front.

- **Dark**

Depending on configuration this state can be activated by the power key and/or on timeout. In this state everything is off (dark) on the device.

## 2.2 Access Level

To prevent unauthorized or accidental changes to the system, the device has a “locked” state. Typical use-case is public areas where it is not desired for any passerby to change setpoint or control lights.

The device enters locked state on a timeout (no buttons tapped for a while).

Different installations may require different scenarios for locking or unlocking the device. Therefore, the device can be configured to operate in 4 different access levels. The allowed states and their sequence for each configuration are as follows:

- **Default access level** : Sleep << >>Operational
- **Simple access level** : Sleep << >> Display Only <<- key combination ->>Operational
- **Secure access level** : Sleep << >> Display Only <<- enter passkey ->>Operational
- **No Access Level** : Sleep << >> Display Only

## 2.3 Activating The Screen

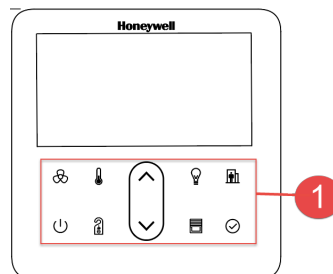

The device may switch to sleep or dark state, if no action is taken in a defined time span. In this state screen appears to be black-out. Tap any key on the keypad to activate the screen.



## 2.4 Unlocking The Device

Once the device is activated, it may be in locked mode (display only), to prevent unauthorized access to the device. In lock mode,  appears on the screen and key on the keypad are disabled.

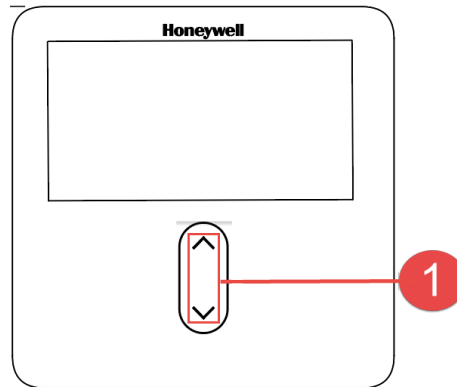

The procedure to unlock the device is as follows:

1. Press   together for a while, Pin entry screen appears.
2. Enter the Pin to unlock the screen. Refer [Entering The Pin](#) section to enter the Pin.



### 2.4.1 Entering The Pin

The procedure to enter protection Pin or configuration pin is as follows:

1. Press Up/down Key to set the flashing digit between 0 to 9.
2. Press , to enter next digit.
3. Press , to move the cursor back to the previous digit.
4. Press  on the last digit, to evaluate the entered Pin.

**Note:** Press power key to change last entered digit or to cancel the entered Pin and return to previous screen/mode.

### 2.4.2 Monitoring Current Status and Values

The wall module has a rich interface that allows you to observe current status at a glance and access more information with just a few taps.

Most of the information related to current status is represented by symbols on the screen. To view more information:

- Tap  to enter monitoring mode

- Use  $\wedge/\vee$  to scroll between available values. Each value will be displayed together with unit and sequence number.
- To hold any parameter on display long press ok key for 2 sec.
- Tap OK again to return to Operating mode.

## 2.5 Adjusting Temperature

when the device is unlocked user can change the temperature setpoint value. The procedure to change the temperature setpoint value is as follows:

1. Tap  $\wedge/\vee$ , to enter in temperature Setting mode.  
The screen shows the currently active setpoint (flashing).

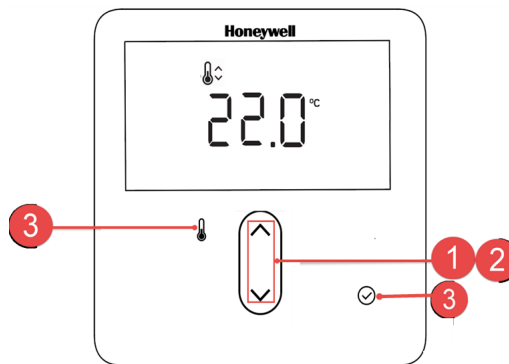

**Note:** If setpoint change is disabled by the controller, then  $\wedge/\vee$  are disabled.

2. Tap  $\wedge/\vee$  to set desired temperature value.
3. Tap  $\checkmark$  to save new setpoint value and exit.

**Note:** Tap  $\text{temp}$  icon, to exit without saving the changes and retain the previous set point value. In case of timeout, it will exit the mode without saving the changes.

### 2.5.1 Changing The Temperature Unit

The temperature unit can be changed by pressing the temperature key if the device is in ready state. Depending on configuration, this may require a long press.

**Note:** In some configurations, unit change may be disabled. Contact Service engineer to enable it.

## 2.6 Adjusting The Fan Speed





Tap  to change the fan speed. The settings are slightly different depending on type of fan. Two types of fans are supported by TR80 wall module such as:

- Multi-Speed Fans
- EC Fans

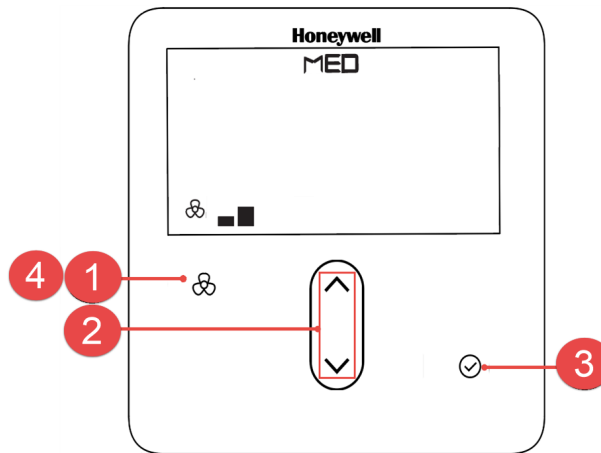
### 2.6.1 Multi Speed Fans

In this type of fan, display shows selected fan speed in upper display (OFF/LO/MED/ HI), AUTO symbol and fan speed is displayed at the bottom. Refer the figure shown below.



1. Tap  in operating mode, to enter in fan speed Setting mode.
2. Tap  or , to set the fan speed (OFF, LO, MED, HI, AUTO).
3. After selecting fan speed tap .
4. Tap  to exit the mode.

## 2.6.2 EC Fans

In this type of fan setting, display shows FAN in upper display and fan speed along with unit in larger display. In this fan speed setting is done in terms of percentage (0 to 100%). Refer the figure shown below.

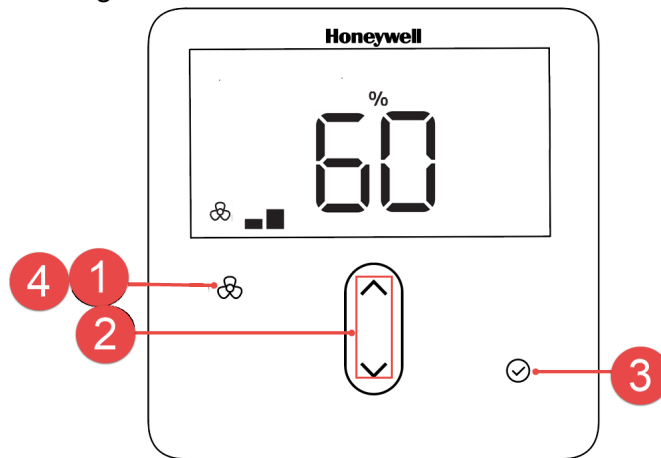

The procedure to do fan speed setting for Speed fan is as follows:

1. Tap to enter in fan speed Setting mode.
2. Tap to set, the fan speed in % .
3. After selecting fan speed tap .
4. Tap to switch between auto / min speed / manual.

## 2.7 Selecting Or Overriding Occupancy status

The wall module provides two type of occupancy modes depending upon the device configuration such as:

- Simple Occupied/ unoccupied selection
- Advanced Occupancy selection

### 2.7.1 Simple Occupied/ unoccupied selection

In this mode, occupancy status is determined by the user. The procedure to switch between Occupied/ unoccupied mode is as follows:



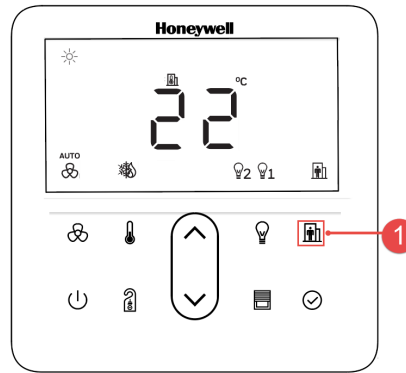

1. Tap to switch between Occupied/ unoccupied mode.  
The current active occupied/ unoccupied mode is indicated by occupancy symbol on the display.



## 2.7.2 Advanced Occupied/ unoccupied selection

In this mode, occupancy status is set by the master controller by considering various factors like time schedule, motion sensor, a key-card system etc.

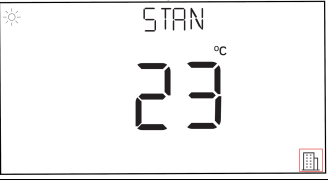
The various possible occupancy status are indicated on the screen as shown in the below table.

Occupancy Status	Description
Occupied	Room is occupied and would typically operate in comfort mode. The display will show occupancy symbol at the right bottom corner. <div style="text-align: center;">  </div>
Unoccupied	Room is unoccupied would typically operate in a building protection mode. The display shows unoccupied symbol with text "AWAY". <div style="text-align: center;">  </div>
Standby	Room is not occupied yet, it is kept in ready to occupy condition. The display shows unoccupied symbol with scrolling text "STAN BY". <div style="text-align: center;">  </div>
Bypass	The user has overridden the automatic mode and switched the system to comfort mode temporarily. The display shows occupied symbol with scrolling text "Comfort for ... mins". <div style="text-align: center;">  </div>







Occupancy Status	Description
Holiday	<p>The user has overridden the automatic mode and switched the system to building protection mode temporarily. The display shows unoccupied symbol with scrolling text "Holiday for ... days"</p> 

### 2.7.2.1 Overriding the occupancy mode

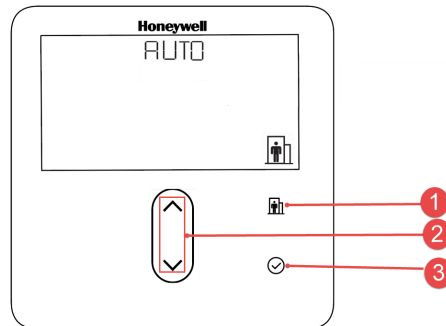
The user can override the automatically determined mode, if configuration allows. when an user override is active, the occupancy symbol is blinking.

1. Tap  to change the occupancy mode.  
The display will show blinking text "AUTO".



2. Tap  to select the desired override occupancy mode.
3. Set the Bypass time in minutes if Bypass occupancy mode is selected or set the Holiday period in number of days if Holiday Mode is selected.
4. Tap  to exit without saving press.
5. Tap  to activate and Save the selected override occupancy mode.

**Note:** The availability of options and mode depend on the device configuration.

## 2.8 Selecting / Overriding HVAC mode

The HVAC modes can be changed from wall module depending on the configuration. Below methods are used to change the HVAC mode such as:

- Simple operation : Wall module user determines the HVAC mode
- Advanced operation: HVAC mode is determined in the controller. The user can temporarily override the automatically determined mode.

The procedure to change the HVAC mode is as follows:

1. Tap , to change the HVAC mode.  
The display shows the text and symbol indication of the currently selected mode.

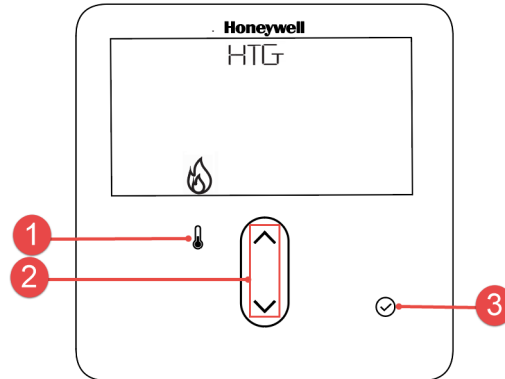

2. Tap  to select the HVAC mode.

**Note:** Tap  to exit this mode without saving the changes.



3. Tap  to activate the selected HVAC mode.

## 2.9 Selecting ECO operation

In some installations, user can select ECO operation. Long-pressing the down button will toggle the ECO symbol . In ECO operation, the system consumes less energy.

## 2.10 Controlling Lights

TR80 allows control of up to 4 lighting groups. The procedure to select group is as follows:

1. Tap , to enter lighting mode.  
The display shows the selected light group, light level and/or scene selected for that group.
2. Tap , to select another light group.
3. Tap , to exit.

After group selection, one of the following four methods will be available for controlling lights depending on installation.

## 2.10.1 Basic on/off control

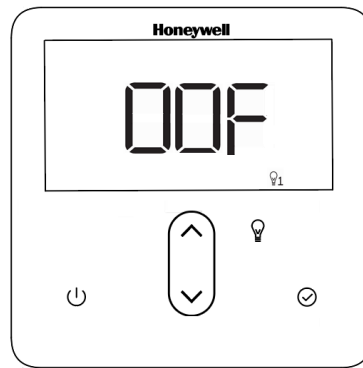

- The display shows the current light level as text (On / OFF).
- Use { ^/∨ } keys or the {⏻} key to turn the lights on/off.

## 2.10.2 Basic dimming control

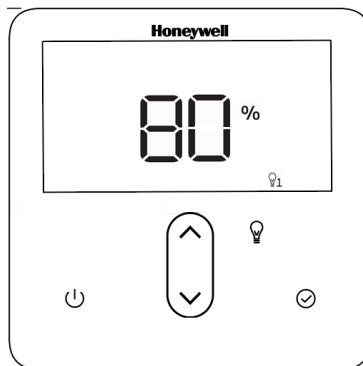

- The display shows current (or last selected) light level as percentage.
- Use ^/∨ to dim the lights up or down
- When dimming down, the adjustment may stop at a preset minimum level. Keep the down key pressed, or release and re-tap it, to turn the light group completely off.
- Tap ⏻ to switch between OFF and last selected level.

## 2.10.3 On/off control with scene selection

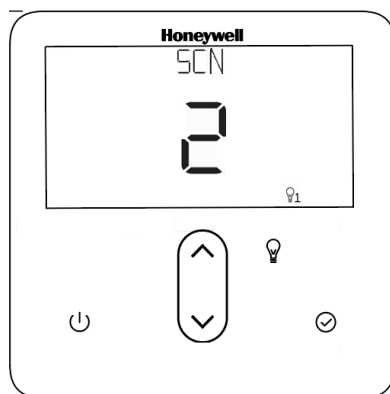

- The display shows last activated scene number
- Use  $\wedge/\vee$  to switch between and activate preset scenes
- Use the power button to switch between OFF and last activated scene.

## 2.10.4 Dimming control with scene selection

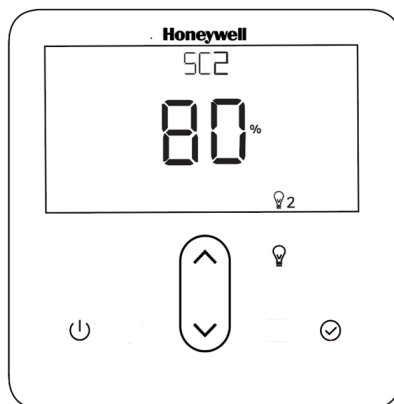



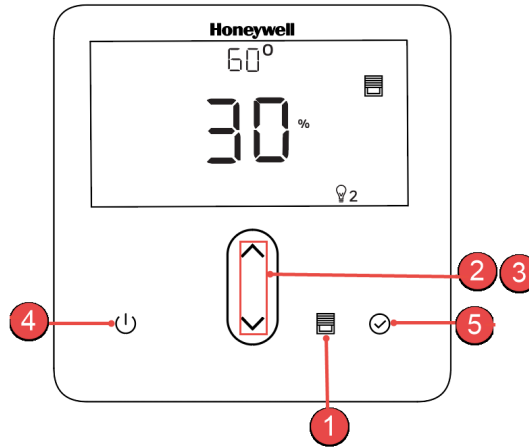

- The display shows current (or last selected) light level as percentage and last selected scene number.
- Short-tap  $\wedge/\vee$  to switch between and activate preset scenes
- Long-press  $\wedge/\vee$  to dim the lights up or down
- Use the  $\cup$  to switch between OFF and last selected level or scene.

## 2.11 Controlling Blinds

User can set slat angle, set blind position, toggle between the blinds and switch between 0% and last set value. The procedure to set the blind control is as follows:



1. Tap  in Ready mode, to enter in blind control mode. The display shows current blind position in the lower display area and the current slat angle in the upper area.
2. Tap , to change slat angle.
3. Long press , to change blind position.
4. Tap  to switch the blinds between fully closed & current position.
5. Tap , to exit this mode.

## 2.12 DO-NOT-DISTURB / MAKE-UP-ROOM

A hotel guest can activate Do-not-Disturb or Make-up-Room functions by tapping the DnD/MuR Key.

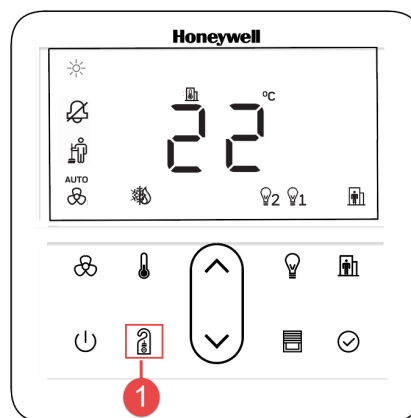



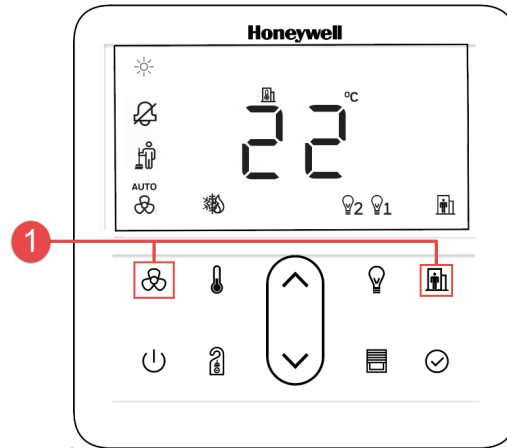

## 2.13 Cleaning The Front Glass

To prevent accidental key presses, the keypad can be disabled for wiping the front glass surface.



The steps to be followed before cleaning the front glass is as follows:

1. Press  and  key together for three seconds to enter cleaning mode. LCD shows make-up-room symbol blinking, lock symbol on, and a countdown in seconds. The default countdown is 60 seconds. Cleaning mode exits automatically after countdown.
2. Press  and  key together for three seconds to exit the cleaning mode.

## 3.1 INTRODUCTION



This chapter provides descriptions for all Modbus registers and configuration parameters that can be used to adopt the TR80 to specific requirements.

The information is provided in tables, showing:



- Modbus register type (Coil / Input / Holding)
- Modbus register address in two schemes (decimal and absolute)
- Modbus register direction (R = Read Only; R/W = Read/Write)
- Unit and scaling for modbus read/writes where necessary
- Configuration parameter number, if it is a parameter that appears on the device config menu.
- Factory default value.
- Most registers and configuration parameters are self-explanatory, but further explanations are provided for most.





### 3.1.1 Entering the configuration mode

Only installer or authorized service engineer can access this mode. The procedure to configure parameter is as follows:

1. Long press  and  together to enter in configuration mode. The setting icon is displayed on the screen.
2. Enter the Pin. Refer [Entering The Pin](#) section for more details.

**Note:** *Default pin is 4663. Change the default pin on completion of commissioning. Refere [User access control and timeouts](#) to change pin*

3. Tap / to change selected parameter. Parameter Number keep blinking at the top part of the display and the parameter's value on the bottom part.

4. Tap , to select Parameter value, the parameter value will start blinking. Use  key to change parameter value and tap OK to save It.
5. Use  to go to other parameter.
6. Tap , to exit the Configuration mode.

## 3.1.2 Temporary Commissioning Mode

User can set TR80 in a temporary commissioning mode, by setting time in parameter 17 when this mode is ON.

- The sleep mode will not be activated on timeout. The display will remain on.
- The protected mode will not be activated on timeout. The device will remain unlocked.
- Entering the configuration menu will not require PIN.
- The symbol  will be flashing.

This mode can be set up to 336 hours (14 days). It can be cancelled at any time by setting the same parameter to 0.

## 3.1.3 Factory Reset

The factory reset procedure is as follows:

1. Turn off and turn ON the unit .
2. Wait until the version info is displayed.
3. While version is displayed on the screen, press and hold  for 30 seconds. Device will restart and all parameter values will return to default value.

# 3.2 DEVICE

## 3.2.1 Save Changes

When configuration parameters are modified through the TR80 keypad, the changes are immediately saved to flash memory. However, when parameters are changed by a master controller via Modbus, they are kept in volatile memory, to save the parameters in non-volatile flash memory use below.

Register type	Relative Address	Absolute Address	Dir	Name	Default value
Coil	0	00001	W	Save Changes	0

The master controller needs to write a value of 1 to this register to commit changes to flash memory. The write to flash memory only occurs on a change from 0 to 1. The text 'SAVE' on the screen is displayed temporarily when this function is triggered.



## 3.2.2 Device Information

Register type	Relative Address	Absolute Address	Dir	Name	Config parameter	Type	Range
Input	1	30002	R	Firmware Version major.minor	0	2 x 8bits	0-255 0-255
Input	2	30003	R	Firmware Version bug.build	1	2 x 8bits	0-255 0-255

The Firmware version consists of four parts as detailed below. The four parts are encoded in 2 registers. In each register, the MSB 8 bits encode the first two parts and the LSB 8 bits encode the last two parts.

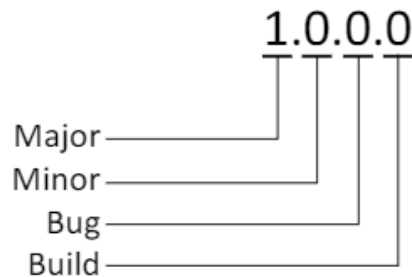

Major: Functional changes, new features, and/or Modbus interface changes

Minor: Minor changes not affecting function or simple user-interface tweaks

Bug: Bug-fixes, no functional change;

Build: Internal build number

## 3.2.3 Config identification

These registers can be set by a master controller to save a particular ID and date code on the device for future reference and identification. They are not used internally. They can also be read from the configuration menu.

Register type	Relative Address	Absolute Address	Dir	Name	Config parameter	Type	Range	Default value
Holding	2000	42001	R/W	Reserved	Reserved	Reserved	Reserved	Reserved
Holding	2001	42002	R/W	Config Date Code	3	2 x 8bits	21-99 1-52	0
Holding	2100	42101	R/W	Room number	100	int	0-9999 or 32767	32767 (undefined)

## 3.3 COMMUNICATION

### 3.3.1 Port 1 configuration

The TR80 wall module is a Modbus slave on its port 1.

Register type	Relative Address	Absolute Address	Dir	Name	Config parameter	Type	Range	Default value
Holding	2002	42003	R/W	Modbus slave address	4	int	1-247	2
Holding	2003	42004	R/W	Port 1 baud rate	5	enum	0: 1200 baud 1: 2400 baud 2: 4800 baud 3: 9600 baud 4: 14400 baud 5: 19200 baud 6: 38400 baud	5
Holding	2004	42005	R/W	Port 1 parity	6	enum	0: none 1: odd 2: even	2
Holding	2005	42006	R/W	Port 1 number of stop bits	7	int	1-2	1

### 3.3.2 Port 2 configuration

Port 2 on the TR80 wall module has two functions. It can act as a repeater between a master controller and a downstream DALI64 sensor. Secondly, it can send basic light level and scene commands of the user directly to a DALI64MOD sensor. These two functions do not conflict, they can be used simultaneously.

Register type	Relative Address	Absolute Address	Dir	Name	Config parameter	Type / Unit	Range	Default value
Holding	2006	42007	R/W	Port 2 baud rate	8	enum	See port 1*	5
Holding	2007	42008	R/W	Port 2 parity	9	enum	See port 1*	2
Holding	2008	42009	R/W	Port 2 number of stop bits	10	int	1-2	1
Holding	2009	42010	R/W	Port 2 Response Timeout	11	msec	200-3000	500
Holding	2010	42011	R/W	DALI64 slave address	12	int	0-247 (0=disabled)	0

\*Baud rate and parity enumerations are same as [Port 1 configuration](#).

If a DALI64 sensor is connected on port2, the DALI64 device's slave address must be set on configuration parameter 12.

## 3.4 GENERAL MONITORING REGISTERS

### 3.4.1 Fault Conditions

Device Faults register indicates several fault conditions that may exist on the device.

Register type	Relative Address	Absolute Address	Dir	Name	Type	Range	Default value
Input	3	30004	R	Device Faults	bitwise	Bit 0: (reserved) Bit 1: on-board sensor fault Bit 2: external sensor fault Bit 3: Port1 modbus loss of comms Bit 4: Port2 receive timeout Bit 5: Setpoint min/max mismatch Bit 6: Fan Speed min/max mismatch Bit 7: Lights min/max mismatch Bit 8: Blinds min/max mismatch	0

The same information is displayed on the screen with the same error numbers. For example, a display of “E02” indicates an external sensor fault.

Port 1 comms fault is activated when no comms is received from master for 60 secs.

External sensor fault (bit2) is determined with comparison against the below valid ranges:

- NTC sensors: -10...+60 °C
- 0-10V input: 0...11 V
- 2-10V input: 1.5...11 V

### 3.4.2 Override Status and Reset

Register type	Relative Address	Absolute Address	Dir	Name	Type	Range	Default value
Input	4	30005	R	Override status	bitwise	Bit0: Setpoint changed from the default Bit1: Fan speed is overridden (not auto) Bit2: HVAC mode overridden Bit3: {reserved} Bit4: Occupancy overridden Bit5: DnD active Bit6: MuR active	0
Holding	1000	41001	R/W	Override reset	bitwise	Bit0: Reset Setpoint Bit1: Reset Fan Speed to AUTO Bit2: Clear HVAC mode override Bit3: Clear Occupancy Override except for holiday Bit4: Clear Occupancy Override include holiday Bit5: Clear DnD Bit6: Clear MuR Bit7: Reset temperature unit to °C Bit15: Restart wall module and clears all user setting (Configuration setting saved to flash memory remain unchanged).	0

An override cancellation occurs when a bit is set (on a change from 0 to 1). The wall module takes no action when a bit is cleared.

### 3.4.3 What has changed

This register changes when the user makes any adjustment on the wall module. It can be utilized by a master controller to reduce comms. It will be sufficient for the controller to read only this register until a non-zero value is received. Then, and only then, the controller would need to read the new user setting from the relevant register.

Register type	Relative Address	Absolute Address	Dir	Name	Type	Range	Default value
Input	9	30010	R	What has changed	bitwise	Bit0: Setpoint Bit1: Fan speed Bit2: HVAC mode Bit3: {reserved} Bit4: Occupancy Bit5: DnD/Mur Bit6: {reserved} Bit7: Temperature unit Bit8: Light group 1 Bit9: Light group 2 Bit10: Light group 3 Bit11: Light group 4 Bit12: Blind 1 Bit13: Blind 2	0

It is important to note that this register automatically returns to the default value of 0 as soon as it is read by the master controller. There is no need for the master to reset it.

### 3.4.4 Active Display Mode

This register allows monitoring of the current user mode.

Register type	Relative Address	Absolute Address	Dir	Name	Type	Range
Input	100	30101	R	Active display mode	enum	0: Dark mode 1: Sleep mode 2: Ready mode 3: Protected mode 4: Setting mode (temp, light etc) 5: Config mode 6: Cleaning mode 7: Pin entry

## 3.5 SENSORS & EXTERNAL INPUT

### 3.5.1 Configuration

Register type	Relative Address	Absolute Address	Dir	Name	Config parameter	Unit	Range	Scale	Default value
Holding	2011	42012	R/W	External sensor type	13	enum	0: NONE 1: NO contact 2: NC contact 3: 0-10 Vdc 4: 2-10 Vdc 5: Raw Ohms 6: NTC10K 7: NTC20K		0
Holding	2012	42013	R/W	On-board sensor temp offset	14	K	-10.0 ... +10.0 K	0.1	0
Holding	2013	42014	R/W	On-board sensor humidity offset	15	%Rh	-10 ... +10 %Rh	1	0

### 3.5.2 Monitoring

Register type	Relative Address	Absolute Address	Dir	Name	Unit	Scale	Default value
Input	5	30006	R	External input measured value	See below	See below	0
Input	6	30007	R	Onboard temp sensor measured value	°C	0.1	0
Input	7	30008	R	Onboard humidity sensor measured value	%Rh	1	0

Unit and scale of the external sensor input depend on configured signal type:

Configuration	Unit	Scale
Raw ohms	Ohms	1
NTC	°C	0.1
Voltage (0-10V or 2-10Vdc)	Percent	0.1
NO contact	0=open, 1=closed	
NC contact	0=closed, 1=open	

Temperature values on Modbus are always in degrees Celsius, even if the user has selected Fahrenheit for display.

## 3.6 DO-NOT-DISTURB & MAKE-UP-ROOM

Do-not-Disturb and/ Make-Up-Room functions can be enabled individually. The button on the TR80 will be enabled only if at least one of these functions are enabled.

Register type	Relative Address	Absolute Address	Dir	Name	Config parameter	Type	Range	Default value
Input	3	30009	R	DnD/MuR status	-	enum	0: none 1: DnD 2: MuR	0
Holding	2014	42015	R/W	DnD/MuR enable	16	enum	0: disabled 1: DnD enable 2: MuR enable 3: Dnd/Mur enable	1

## 3.7 CLEANING MODE

It is possible to monitor if the device is currently switched to cleaning mode (Refer [Cleaning The Front Glass](#)). This could be utilized, for example in hotel applications, to monitor if house-keeping has already done the cleaning for a guest room.

Register type	Relative Address	Absolute Address	Dir	Name	Config parameter	Type	Range	Default value
Input	101	30102	R	Cleaning mode status	-	enum	0: no 1: yes	0
Holding	2109	42110	R/W	Cleaning mode timeout	107	secs	10-7200 secs	60 s

## 3.8 USER INTERFACE

### 3.8.1 Backlight Brightness

Register type	Relative Address	Absolute Address	Dir	Name	Config parameter	Type	Range	Default value
Holding	2103	42104	R/W	Backlight brightness	101	int	0-100%	100%

## 3.8.2 LED Ring

These registers can be used to determine or override the default color and behavior of the LED ring.

Register type	Relative Address	Absolute Address	Dir	Name	Config parameter	Type	Range	Default value
Holding	2104	42105	R/W	Ring brightness	102	int	0-100%	100%
Holding	2105	42106	R/W	Ring brightness in sleep mode	103	int	0-100%	75%
Holding	1100	41101	R/W	Ring colour	-	RGB565	0-65535	0 (Auto)
Holding	1101	41102	R/W	Ring style	-	enum	0: auto 1: off 2: steady 3: slow breath 4: medium breath 5: fast breath 6: blink 7: fast blink	1

Ring brightness in normal operation and ring brightness in SLEEP mode can be individually set. The ring colour and style normally change automatically based on hvac mode (heating = orange, cooling = blue...) received from controller (Refer [HVAC mode selection](#)). The master controller can override the automatically determined colour by writing a value to the 'Ring Colour' register. The format is RGB565 (5 bits red, 6 bits green, 5 bits blue from most significant to least). A value of 0 (corresponding to black) represents AUTO mode, meaning the LED ring changes colour according to currently active hvac mode.

The controller can also override the ring style by writing to holding register 1101.



## 3.8.3 Temperature display configuration

Register type	Relative Address	Absolute Address	Dir	Name	Config parameter	Type	Range	Default value
Holding	2106	42107	R/W	Room temperature display resolution	104	Enum	0: don't display 1: 1 deg resolution 2: 0.5 deg resolution 3: 0.1 deg resolution	1
Holding	2107	42108	R/W	Outdoor temperature display resolution	105	enum	0: 1 deg resolution 1: 0.5 deg resolution 2: 0.1 deg resolution	2
Holding	2108	42109	R/W	Temperature unit & user change option	106	enum	0: °C (user can change) 1: °F (user can change) 2: °C (fixed) 3: °F (fixed)	0

It is possible to disable temperature unit change on the wall module and have it fixed in Celsius or Fahrenheit.

## 3.8.4 LCD Symbols

Most symbols on the LCD are activated with internal logic depending on current status (occupancy etc). Other symbols can be only activated via Modbus by a master controller, as explained below.

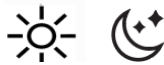
Register type	Relative Address	Absolute Address	Dir	Name	Type	Range	Default value
Holding	1102	41103	R/W	Window open symbol 	Enum	0: off 1: on 2: blink	0
Holding	1103	41104	R/W	ECO symbol 	Enum	0: off 1: on 2: blink	0
Holding	1104	41105	R/W	Alarm symbol 	Enum	0: off 1: on 2: blink 3: auto	3
Holding	1105	41106	R/W	Day/night symbol 	Enum	0: off 1: sun symbol on 2: moon symbol on 3: sun symbol blink 4: moon symbol blink	0

The alarm symbol is normally activated by internal fault conditions (see [Fault Conditions](#)). The master controller can override this as above.

## 3.8.5 Text override

If a non-zero value is written to this register, the upper screen area will display the selected scrolling text. This overrides any other text that might otherwise be displayed.

Register type	Relative Address	Absolute Address	Dir	Name	Type	Range	Default value
Holding	1106	41107	R/W	Text override	enum	0: none 1: "Fan Off" 2: "Clg/Htg Off" 3: "Window Open" 4: "Condensation" 5: "Fire" 6: "Service required"	0



## 3.8.6 Power button functions

For the device's READY mode, the power button can be assigned different functions.

Register type	Relative Address	Absolute Address	Dir	Name	Config parameter	Type	Range	Default value
Holding	2110	42111	R/W	Power Button Short Press Function	108	enum	0: No function 1: Dark Mode 2: Sleep Mode 3: SwitchLightsOnOff Toggle 4: SwitchLights On 5: SwitchLights Off	2
Holding	2111	42112	R/W	Power Button long Press Function	109	enum	Same as above	0
Holding	115	2118	R/W	Departure delay	42119	secs	0-300 seconds	10 s
Input	102	30103	R	Power Button user command	-	enum	0: default 1: Lights On activated 2: Lights Off activated	

The power button function is described in the below table.

Value	Function	Description
0	No Function	The power button will not be enabled
1	Dark Mode	The power button activates dark mode.
2	Sleep Mode	The power button switches the device to SLEEP mode.
3	Switch Lights On Off Toggle	With each tap, the power button toggles on/off commands to all defined lighting groups.
4	Switch Lights On	On every tap, the power button sends on command to all defined lighting groups.
5	Switch Lights Off	On every tap, the power button sends off command to all defined lighting groups.

TR80 is primarily a display, not a control device. Therefore, further settings and some configuration on the master controller or DALI side are required for these functions to work.

### Relevant TR80 settings:

- **Departure delay:** This is a parameter on the TR80 with a default of 10 seconds. When the power-button press is to activate 'Lights Off' command, the display will count down from this value before executing the command. This is to ensure the room tenant is not left in the dark when exiting.
- **Scene settings for lights on & off:** If a DALI64 sensor is on port 2, the TR80 can turn the lights on/off directly without involving the master controller. It will do that by sending 'recall scene' commands to the DALI64 sensor. Therefore, it is necessary to set which scenes numbers are configured on the DALI side to turn the lights fully off or fully on. These settings are detailed in section 3.11.6.
- If a scene number is not set for Lights On or Lights Off functions, TR80 will send absolute light level commands (100% / 0%) instead.

Required master controller logic:

- The master controller can become aware of the user action Lights On / Lights Off by reading the input register 102. It is important to note that this automatically returns to 0 when the master reads it. There is no need for the master controller to reset it.
- After receiving Lights On / Lights Off command, the master controller may execute additional functions (e.g. changing occupancy mode, cancelling overrides, turning lights on/off, adjusting shutters...)
- If Lights On/Lights Off toggle operation is configured, TR80 will check the 'Group Light State' register (see [LIGHTING CONTROL](#)) or light level feedback registers (section [Light Group 1 configuration](#)) to determine which command to execute on first press. If any light is on in any group, lights will be turned off. Otherwise, they will be turned on.

## 3.8.7 User access control and timeouts

Register type	Relative Address	Absolute Address	Dir	Name	Config parameter	Type	Range	Default value
Holding	2112	42113	R/W	User access protection	110	enum	0: free 1: simple 2: secure 3: no access	0
Holding	2113	42114	R/W	User access Pin	111	int	0000...9999	0000
Holding	2114	42115	R/W	Config menu Pin	112	int	0000...9999	4663
Holding	2115	42116	R/W	Timeout to sleep mode/lock	113	secs	0-300 secs	15 s
Holding	2117	42118	R/W	Timeout to dark mode	114	secs	0-300 secs (or 32767)	32767 (disabled)

### User Access Protection :

To prevent unauthorized or accidental changes to the system, the device has a “locked” status. Typical use-case is public areas where any passerby should not be able to change setpoint or control lights. Different installations may require different scenarios for locking or unlocking the device. The ‘user access protection’ parameter determines lock operation. The options are:

1. Free: the user can freely access controls. Device never locks automatically on timeout. If it is intentionally locked by the set key combination (e.g., for cleaning), it will unlock automatically after some time. This is the default and most common setting.
2. Simple: Device will lock automatically on timeout. User needs to use a key combination (long press up-down keys together) to unlock and access controls.
3. Secure: Device will lock automatically on timeout. User needs to enter a 4-digit pass-key to unlock and access controls ('user access pin', holding register 2113, config parameter 111).
4. No access: device will always be in locked status. No user access to settings in anyway.

### Timeout to lock status :

If no buttons are touched for this period, the device will enter sleep mode, turning off the display and buttons. Set to zero to have the display remain continuously on.

### Timeout to dark mode :

If device is in sleep mode and no buttons are touched for this period, the device will enter dark mode turning off the display, all buttons and LED ring. If set to 0, it will immediately enter dark mode on sleep mode timeout (see above). Set to 32767 to disable.

## 3.9 HVAC

### 3.9.1 Temperature setting

The TR80 can operate in absolute or relative setpoint mode. In relative setpoint mode, the user does not see the absolute setpoint, but has the option to shift it up or down, typically by +/-5 degrees.

Register type	Relative Address	Absolute Address	Dir	Name	Config parameter	Type	Range	Scale	Default value
Holding	2200	42201	R/W	Setpoint style	200	enum	0: absolute 1: relative	-	0
Holding	2201	42202	R/W	Setpoint minimum	201	signed int	-10...+40 °C	0.1	10 °C
Holding	2202	42203	R/W	Setpoint maximum	202	signed int	-10...+40 °C	0.1	30 °C
Holding	2203	42204	R/W	Default Setpoint	203	int	-10...+40 °C	0.1	22 °C
Holding	1200	41201	R/W	User setpoint	-	signed int		0.1	22°C
Input	202	30203	R	User setpoint limited	-	signed int		0.1	

'User Setpoint' (holding register 1200) changes every time the user makes an adjustment on the wall module. Master controller can write to this register to override the user selected setpoint. Master controller can also reset the setpoint to the default value by using the 'Override Reset' Refer [Override Status and Reset](#) section.

The master controller can disable user setpoint adjustment by setting the min and max registers to the same value.

'User setpoint limited' (input register 202) is derived from 'User setpoint' but internally limited between min & max settings. The 'User Setpoint' register value can fall outside of the min/max range, if the master controller reduces the range by writing to the min/max registers, for example when switching to unoccupied or standby modes.

## 3.9.2 Fan Speed Control

Register type	Relative Address	Absolute Address	Dir	Name	Config parameter	Type	Range	Default value
Holding	2204	42205	R/W	Fan type	204	enum	0: no fan 1: Single speed fan 2: 2-speed fan 3: 3-speed fan 4: EC fan	3
Holding	2205	42206	R/W	EC Fan speed adjust step size	205	enum	0: 1% 1: 2% 2: 5% 3: 10% 4: 20%	3
Holding	2206	42207	R/W	Fan speed low-limit	206	Int	0-100 % for EC fans, 0-3 for others	0
Holding	2207	42208	R/W	Fan speed high-limit	207	Int	0-100 % for EC fans, 0-3 for others	100
Holding	2208	42209	R/W	Fan UI attributes	208	bitwise	See below	1
Holding	1202	41203	R/W	Fan speed feedback	-	int	EC Fans: 0..100% Others: 0..3 Unknown/invalid: 32767	32767
Input	201	30202	R	User fan speed	-	int	EC Fans: 0..100% Others: 0..3 (Off-Lo-Med-Hi) Auto= 0x7FFF	32767

'User fan speed' (input register 201) changes every time the user makes a fan-speed adjustment on the wall module.

'Fan speed feedback' (holding register 1202) is used for local display when the user fan speed is selected as AUTO.

'Fan UI attributes' (holding register 2208) register description:

- Bit 0: Allow fan override (0: not allowed; fan button disabled / 1: Override allowed)
- Bit 1: Display type for single-stage fan (0: 1 bar, 1: 3 bars)

### 3.9.3 HVAC mode selection

TR80 allows two different Hvac mode selection options: simple or advanced. In simple mode, the occupancy button simply and directly switches between available modes (heat-ing/cooling/fan-only...) similarly to a basic A/C unit.

Applications that have more complicated requirements (for example having two different cooling systems within the same room) can use the advanced mode.

Register type	Relative Address	Absolute Address	Dir	Name	Config parameter	Type	Range	Default value
Holding	2209	42210	R/W	HVAC mode selection type	209	enum	0: disabled 1: simple 2: advanced	0
Holding	2210	42211	R/W	Available HVAC modes	210	enum	Bit0: "AUTO" Bit1: "HEAT" Bit2: "COOL" Bit3: "FANONLY" Bit4: "OFF" Bit5: "HTG1" Bit6: "HTG2" Bit7: "CLG1" Bit8: "CLG2"	15 (auto, heat, cool, fan)
Holding	1201	41202	R/W	Ring behavior depending on cooling and heating	-	enum	See Below	0
Input	200	30201	R	User selected HVAC mode	-	enum	0: Auto 1: Heating 2: Cooling 3: Fan-only 4: Off 5: Heating 1 6: Heating 2 7: Cooling 1 8: Cooling 2	0

Register 1201 allows a master controller to control the LED ring to indicate the status of cooling and heating in the room. A constant blue means that cooling mode is active, but is not currently switched on. A constant orange means that the heating mode is active, but is not currently switched on. The ring begins to breathe as soon as the room is cooled or heated. A breathing green means the fan is on with no cooling and no heating. Gray means that no cooling and no heating is currently possible; the central cooling and heating system is turned off or the room user has disabled cooling or heating via a HVAC Mode overwrite.

Register 1201 is encoded as follows:

- Bit representation: 000D CCBB 0000 OAAA
  - AAA (bits 2-0): currently active hvac mode
  - BB (bits 9-8): Heating outputs status
  - CC (bits 11-10): Cooling outputs status
  - D (bit 12): fan output status

- **Bits 0..2:**
  - 000 (0): heat & cool not available (grey ring)
  - 001 (1): Cooling mode (blue ring)
  - 010 (2): Heating mode (orange ring)
  - 011 (3): Heating+cooling (purple ring)
  - 100 (4): Fan-only (green ring)
  - 101 (5): Alarm (red ring)
- **Bits 9..8 (only if orange)**
  - 00 (0): All heat outputs off (steady ring)
  - 01 (256): Heat 1 Output on (slow breath)
  - 10 (512): Heat 2 Output on (medium breath)
  - 11 (769): All heat outputs on (fast breath)
- **Bits 11..10 (only if blue)**
  - 00 (0): All cool outputs off (steady ring)
  - 01 (1024): Cool 1 Output on (slow breath)
  - 10 (2048): Cool 2 Output on (medium breath)
  - 11 (3096): All cool outputs on (fast breath)
- Bit 12 (4096): Fan output on (medium breath - only if green)

## 3.10 OCCUPANCY

Occupancy mode selection on the TR80 can go beyond simple occupied/unoccupied states. Following occupancy states are possible:

- Off
- Unoccupied (displayed as AWAY on device)
- Standby
- Occupied (displayed as COMFORT on device)
- Standby
- Holiday

### 3.10.1 Occupancy source

TR80 allows different options for occupancy selection:

1. Button only: In this simple operation, the wall module is the only source for occupancy. User simply uses the occupancy button to switch between occupied/unoccupied modes manually. No other modes are available.

2. Modbus only: With this setting, the occupancy button on the wall module is disabled. Master controller determines the occupancy mode.
3. Modbus with override from button: In this case, the master controller determines the occupancy mode based on a time schedule, presence detector and/or other inputs. However, the user may be allowed to override the current mode using the occupancy button. This allows user to select further modes such as holiday or bypass.

Register type	Relative Address	Absolute Address	Dir	Name	Config parameter	Type	Range	Default value
Holding	2500	42501	R/W	Occupancy Source	500	enum	0: Modbus only 1: Button only 2: Modbus & override from button	0

## 3.10.2 Occupancy control

Unless the very simple, button-only selection mode is being used, the master controller should write its calculated occupancy mode to the 'master occupancy mode' register. This is necessary for display, override functionality and to determine which overrides are allowed. It would typically be occupied, unoccupied, standby or off.

The master controller should read the user selected occupancy mode from the 'Effective Occupancy Mode' register. This is the register that reflects the current effective mode and that is used for display on the wall module.

Register type	Relative Address	Absolute Address	Dir	Name	Type	Range	Default value
Holding	1500	41501	R/W	Master Occupancy Mode	enum	0: unknown 1: not used 2: occupied 3: off 4: holiday 5: unoccupied 6: standby 7: bypass	0
Holding	1501	41502	R/W	User Occupancy Mode	enum	0: auto 1: not used 2: occupied 3: off 4: holiday 5: unoccupied 6: standby 7: bypass	0
Input	500	30501	R	Effective Occupancy Mode	enum	0: unknown 1: not used 2: occupied 3: off 4: holiday 5: unoccupied 6: standby 7: bypass	0
Input	501	30502	R	Occupancy Override Status	enum	0: not overridden 1: overridden	0

### 3.10.3 Holiday & Bypass overrides

When the user activates Holiday override, the system will remain off (or in building protection mode) until the set time (number of days) expires.

When the user activates Bypass override, the system will remain in comfort mode until the set time (number of minutes) expires.

Register type	Relative Address	Absolute Address	Dir	Name	Config parameter	Unit	Range	Default value
Holding	2501	42502	R/W	Holiday default time	501	days	1-45 or unlimited	7 days
Holding	2502	42503	R/W	Bypass default time	502	mins	10-1440 mins (or 65535 = unlimited)	180 mins
Holding	2503	42504	R/W	Bypass adjust step	503	enum	0: 10 mins 1: 20 mins 2: 30 mins 3: 60 mins	2
Holding	1502	41503	R/W	Bypass remaining minutes	-	mins		0
Holding	1503	41504	R/W	Holiday remaining days	-	days		0
Holding	2509	42510	R/W	Bypass time max	509	mins	30-1440 mins	180 mins

When the user overrides occupancy to holiday or bypass mode and sets the desired time, the relevant remaining time register will be set to the user selected value and displayed on the screen (for example as scrolling text “HOLIDAY FOR 7 DAYS”). The wall module will not automatically count back from the set time. It is the responsibility of the master controller to keep time and update the remaining days/minutes in the relevant register.

### 3.10.4 Allowed User Overrides

This set of parameters determine what occupancy modes the user is allowed to select. The allowed overrides is dependent on the current occupancy mode (holding register 1500, section [Occupancy control](#))

Register type	Relative Address	Absolute Address	Dir	Name	Config parameter	Range	Default value
Holding	2504	42505	R/W	Allowed overrides from OFF	504	Bit0: unused	0
Holding	2505	42506	R/W	Allowed overrides from UNOCC	505	Bit1: unused Bit2: Allow override to OCCUPIED	144
Holding	2506	42507	R/W	Allowed overrides from STANDBY	506	Bit3: Allow override to OFF Bit4: Allow override to HOLIDAY	148
Holding	2507	41508	R/W	Allowed overrides from OCC	507	Bit5: Allow override to UNOCC Bit6: Allow override to STANDBY Bit7: Allow override to BYPASS	176

Default values allow the following overrides

Override mode	Values
From OFF	none
From UNOCCUPIED	Holiday and Bypass
From STANDBY	Occupied, Holiday and Bypass
From OCCUPIED	Unoccupied, Holiday and Bypass



## 3.10.5 Auto-reset of occupancy override

The TR80 can be configured to automatically cancel a user occupancy override when the master occupancy mode changes (holding register 1500, refer [Occupancy control](#)).

Register type	Relative Address	Absolute Address	Dir	Name	Config parameter	Unit	Range	Default value
Holding	2508	42509	R/W	Occupancy Auto Reset	508	enum	see below	55

Bit definitions:

Bit0: When master mode changes to UNOCC, cancel UNOCC override

Bit1: When master mode changes to UNOCC, cancel STBY override

Bit2: When master mode changes to UNOCC, cancel OCC override

Bit3: reserved

Bit4: When master mode changes to OCC, cancel BYPASS override

Bit5: When master mode changes to OCC, cancel OCC override

By default, all bits are set

## 3.11 LIGHTING CONTROL

General lighting configuration parameters are as follows:

Register type	Relative Address	Absolute Address	Dir	Name	Config Parameter	Unit	Range	Default Value
Holding	2300	42301	R/W	Light Group Count	300	int	0..4	2
Holding	2301	42302	R/W	Light adjustment step size	301	enum	0: 1% 1: 2% 2: 5% 3: 10% 4: 20%	3
Holding	1308*	41309	R/W	Group light state	-	bitwise	Bit0: Group 1 is ON Bit1: Group 2 is ON Bit2: Group 3 is ON Bit3: Group 4 is ON	

\*In case direct DALI64 control on TR80 Modbus Port 2 this register is updated automatically. In all other cases the Controller must write On – OFF status of group in this registers to turn on the group on indication.

'Group Light State' bitmap register is used to represent which groups have at least on lamp that is not totally off. This info typically comes from the DALI64MOD sensor.

If the DALI64 sensor is connected to port 2, the TR80 wall module will read the 'Group Light State' directly, without any dependency on a master controller. If DALI64 sensor is connected on port 1 (or a different lighting control system is employed) the master controller will need to provide this information to the wall module.

The 'Group Light State' information (in combination with 'Group Level Feedback') register is used for two purposes:

1. Light groups that are ON are indicated on the LCD with bulb symbols.
2. Where the power button functions to turn the lights on/off, the behaviour for the first tap of the button is determined by the group light states and group level feedback.

## 3.11.1 Light Group 1 configuration

Register type	Relative Address	Absolute Address	Dir	Name	Config Parameter	Unit	Range	Default value
Holding	2302	42303	R/W	Light Group 1 allow dimming	302	enum	0: only on/off control 1: allow dimming	1
Holding	2303	42304	R/W	Light Group 1 min level	303	%	0...100%	1%
Holding	2304	42305	R/W	Light Group 1 max level	304	%	0...100%	100%
Holding	2305	42306	R/W	Light Group 1 number of scenes	305	int	-1-15	4

Set “number of scenes” to 0, to disable scene selection/activation for this group.

## 3.11.2 Light Group 1 control

Register type	Relative Address	Absolute Address	Dir	Name	Unit	Range	Default value
Holding	1300	41301	R/W	Light Group level feedback	%	0-100%	32768 (invalid)
Holding	1301	41302	R/W	Light Group last scene feedback	int	0-15	0
Input	300	30301	R/W	Light Group 1 new level	%	0-100%	32767
Input	301	30302	R/W	Light Group 1 new scene	int	0-15	32767

‘Level Feedback’ and ‘Last Scene Feedback’ information typically comes from the DALI64 sensor. When the user enters the setting mode for any light group these are the values that will be displayed initially, and the user will start setting (incrementing / decrementing) from these values.

The scene settings 0-15 correspond to user scene selections 1-16.

If the DALI64 sensor is connected to port 2, the TR80 wall module will read the ‘Level Feedback’ and ‘Last Scene Feedback’ directly, without any dependency on a master controller. If DALI64 sensor is connected on port 1 (or a different lighting control system is employed) the master controller will need to provide this information to the wall module.

The ‘New Level’ and ‘New Scene’ registers are used to convey user commands to the master controller. These will normally be at an invalid value of 32767. If the user selects a new light level or a new scene on the wall module, the relevant register will contain the newly selected value. But as soon as it is read over Modbus, it will automatically revert to the invalid value of 32767. This scheme ensures all user commands are registered as a change-of-value and can be acted upon by the master controller.

If a DALI64 sensor is connected to port 2, the TR80 will directly send light level or scene recall commands to the DALI64. There is no need for the master to route values in that case.

### 3.11.3 Light Group 2 configuration & control

The configuration parameter for group 2 are explained in below table. Refer lighting group1 for explanation.

Register type	Relative Address	Absolute Address	Dir	Name	Config Parameter	Unit	Range	Default value
Holding	2306	42307	R/W	Light Group 2 allow dimming	306	enum	0: only on/off control 1: allow dimming	1
Holding	2307	42308	R/W	Light Group 2 min level	307	%	0...100%	1%
Holding	2308	42309	R/W	Light Group 2 max level	308	%	0...100%	100%
Holding	2309	42310	R/W	Light Group 2 max Scene No	309	int	0-16	4

The group 2 control parameters are explained in below table. Refer lighting group1 for explanation.

Register type	Relative Address	Absolute Address	Dir	Name	Unit	Range	Default value
Holding	1302	41303	R/W	Light Group level feedback	%	0-100%	32768 (invalid)
Holding	1303	41304	R/W	Light Group last scene feedback	int	0-15	0
Input	302	30303	R/W	Light Group 2 new level	%	0-100%	32767
Input	303	30304	R/W	Light Group 2 new scene	int	0-15	32767

### 3.11.4 Light Group 3 configuration & control

The group 3 configuration parameters are explained in below table. Refer lighting group1 for explanation.

Register type	Relative Address	Absolute Address	Dir	Name	Config Parameter	Unit	Range	Default value
Holding	2310	42311	R/W	Light Group 3 allow dimming	310	enum	0: only on/off control 1: allow dimming	1
Holding	2311	42312	R/W	Light Group 3 min level	311	%	0...100%	1%
Holding	2312	42313	R/W	Light Group 3 max level	312	%	0...100%	100%
Holding	2313	42314	R/W	Light Group 3 max Scene No	313	int	0-16	4

The group 3 control parameters are explained in below table. Refer lighting group1 for explanation.

Register type	Relative Address	Absolute Address	Dir	Name	Unit	Range	Default value
Holding	1304	41305	R/W	Light Group level feedback	%	0-100%	32768 (invalid)
Holding	1305	41306	R/W	Light Group last scene feedback	int	0-15	0
Input	304	30305	R/W	Light Group 3 new level	%	0-100%	32767
Input	305	30306	R/W	Light Group 3 new scene	int	0-15	32767

## 3.11.5 Light Group 4 configuration & control

The group 3 configuration parameters are explained in below table. Refer lighting group1 for explanation.

Register type	Relative Address	Absolute Address	Dir	Name	Config Parameter	Unit	Range	Default value
Holding	2314	42315	R/W	Light Group 4 allow dimming	314	enum	0: only on/off control 1: allow dimming	1
Holding	2315	42316	R/W	Light Group 4 min level	315	%	0..100%	1%
Holding	2316	42317	R/W	Light Group 4 max level	316	%	0..100%	100%
Holding	2317	42318	R/W	Light Group 4 max Scene No	317	int	0-16	4

The group 3 control parameters are explained in below table. Refer lighting group1 for explanation.

Register type	Relative Address	Absolute Address	Dir	Name	Unit	Range	Default value
Holding	1306	41307	R/W	Light Group level feedback	%	0-100%	32768 (invalid)
Holding	1307	41308	R/W	Light Group last scene feedback	int	0-15	0
Input	306	30307	R/W	Light Group 4 new level	%	0-100%	32767
Input	307	30308	R/W	Light Group 4 new scene	int	0-15	32767

## 3.11.6 Scene definitions for Power Button

Wherever the power button function is to turn lights on/off (see register 2110/2111, config parameter 108/109), the wall module will need to know what scenes to recall for that purpose. Set to zero if no such scene is configured on the DALI side. If set to zero, TR80 will send absolute light level commands (0% / 100%) to turn lights off / on.

Register type	Relative Address	Absolute Address	Dir	Name	Config parameter	Unit	Range	Default value
Holding	2318	42319	R/W	Scene For Lights ON	318	Int	-1 - 16	-1
Holding	2319	42320	R/W	Scene For Lights OFF	319	Int	-1 - 16	-1

## 3.12 BLINDS CONTROL

TR80 can control up to 2 blinds, curtains or shutters. General blind parameters are as shown below.

Register type	Relative Address	Absolute Address	Dir	Name	Config parameter	Unit	Range	Default value
Holding	2400	42401	R/W	Blind Group Count	400	int	0...2	1
Holding	2401	42402	R/W	Blind position adjustment step size	401	enum	0: 1% 1: 2% 2: 5% 3: 10% 4: 20%	3
Holding	2402	42403	R/W	Blinds angle adjustment step size	402	enum	0: 1° 1: 2° 2: 5° 3: 10° 4: 15° 5: 20° 6: 25° 7: 30° 8: 40° 9: 50°	3

### 3.12.1 Blind Group 1 configuration parameters

Register type	Relative Address	Absolute Address	Dir	Name	Config parameter	Unit	Range	Default value
Holding	2403	42404	R/W	Blind 1 type	403	bitwise	Bit 0: angle control Bit 1: position direct/reverse	1
Holding	2404	42405	R/W	Blind 1 min pos	404	%	0...100%	0%
Holding	2405	42406	R/W	Blind 1 max pos	405	%	0...100%	100%
Holding	2406	42407	R/W	Blind 1 min angle	406	°	-180°...180°	-80°
Holding	2407	42408	R/W	Blind 1 max angle	407	°	-180°...180°	+80°

Blind type setting detail:

**Bit 0 – Angle Control:**

0 = up/down positioning only – no slat angle control

1 = up/down positioning + slat angle control

**Bit 1 – Position direct/reverse**

0: reverse (up is 0%. Up button changes value 100->0%)

1: direct (up is 100%. Up button changes value 0->100%)

## 3.12.2 Blind Group 1 control parameters

Register type	Relative Address	Absolute Address	Dir	Name	Unit	Range	Default value
Holding	1400	41401	R/W	Blind 1 position feedback	%	0-100%	50%
Holding	1401	41402	R/W	Blind 1 angle feedback	°	-180...+180°	0
Input	400	30401	R/W	Blind 1 new position	%	0-100%	32767
Input	401	30402	R/W	Blind 1 new angle	°	-180...+180°	32767

'Position Feedback' and 'Angle Feedback' information typically come from the master controller. When the user enters the setting mode for any blind, these are the values that will be displayed initially, and the user will start setting (incrementing / decrementing) from these values.

The 'New Position' and 'New Angle' registers are used to convey user commands. These will normally be at an invalid value of 32767. If the user adjusts the position or angle on the wall module, the relevant register will contain the newly set value. But as soon as it is read over Modbus, it will automatically revert to the invalid value of 32767. This scheme ensures all user commands are registered as a change-of-value and can be acted upon by the master controller.

## 3.12.3 Blind Group2 Configuration & Control Parameters

The Blind 2 configuration parameters are as shown below.

Register type	Relative Address	Absolute Address	Dir	Name	Config parameter	Unit	Range	Default value
Holding	2408	42409	R/W	Blind 2 type	408	bitwise	Bit 0: angle control Bit 1: position direct/ reverse	1
Holding	2409	42410	R/W	Blind 2 min pos	409	%	0...100%	0%
Holding	2410	42411	R/W	Blind 2 max pos	410	%	0...100%	100%
Holding	2411	42412	R/W	Blind 2 min angle	411	°	-180°...180°	-80°
Holding	2412	42413	R/W	Blind 2 max angle	412	°	-180°...180°	+80°

The Blind 2 control parameters are as shown below.

Register type	Relative Address	Absolute Address	Dir	Name	Unit	Range	Default value
Holding	1402	41403	R/W	Blind 2 position feedback	%	0-100%	50%
Holding	1403	41404	R/W	Blind 2 angle feedback	°	-180...+180°	0
Input	402	30403	R/W	Blind 2 new position	%	0-100%	32767
Input	403	30404	R/W	Blind 2 new angle	°	-180...+180°	32767

## 3.13 DISPLAY VALUES

In addition to the operationally required ones, TR80 can display several additional values for user information. The master makes these values available to the wall module by writing to relevant registers.

For these registers, the default value is 32767 (hex 7FFF) representing an invalid value. Any of these registers with the invalid value will be ignored by the wall module. As soon as a valid value is received from the master controller, it will be available for viewing by the user. However, if no updates are received for a configurable timeout period, a value will be considered stale and no longer displayed.

### 3.13.1 Room Temperature and Humidity Override

Firstly, override registers are provided in case the master controller needs to display another measurement instead of the on-board sensors.

Register type	Relative Address	Absolute Address	Dir	Name	Unit	Scale	Default value
Holding	1600	41601	R/W	Room temperature (override)	°C	0.1	32767
Holding	1601	41602	R/W	Room humidity (override)	%	1	32767

### 3.13.2 Pre-configured Display Parameters

Several other registers are defined with pre-configured units and scale.

Register type	Relative Address	Absolute Address	Dir	Name	Unit	Scale	Default value
Holding	1602	41603	R/W	Room air quality (TVOC)	(config)	1	32767
Holding	1603	41604	R/W	Room Carbon-dioxide (CO2)	ppm	1	32767
Holding	1604	41605	R/W	Outdoor temperature	°C	0.1	32767
Holding	1605	41606	R/W	Outdoor relative humidity	%Rh	1	32767
Holding	1606	41607	R/W	Pressure	Pa	1	32767
Holding	1607	41608	R/W	Air flow volume	m3/h	1	32767
Holding	1608	41609	R/W	Indoor particulates PM2.5	ug/m3	1	32767
Holding	1609	41610	R/W	Indoor particulates PM10	ug/m3	1	32767
Holding	1610	41611	R/W	Outdoor particulates PM2.5	ug/m3	1	32767
Holding	1611	41612	R/W	Outdoor particulates PM10	ug/m3	1	32767
Holding	1612	41613	R/W	Energy	kW	1	32767
Holding	1613	41614	R/W	Energy	kWh	1	32767

### 3.13.3 Custom User Defined Parameter Unit

A text, up to 4 characters long, can be displayed in the upper screen area. This custom text is configured with two registers, each character encoded as 8-bits. Only A-Z uppercase chars, numbers, minus-sign, slash (/) and space are supported.

The display for these 2 values can be configured as detailed below.

Register type	Relative Address	Absolute Address	Dir	Name	Unit	Scale	Default value
Holding	2603	42604	R/W	Custom parameter 1 text chars 1&2	(config)	1	32767
Holding	2604	42605	R/W	Custom parameter 1 text chars 3&4	ppm	1	32767
Holding	2605	42606	R/W	Custom parameter 1 attributes	°C	0.1	32767
Holding	2603	42604	R/W	Custom parameter 2 text chars 1&2	%Rh	1	32767
Holding	2604	42605	R/W	Custom parameter 2 text chars 3&4	Pa	1	32767
Holding	2605	42606	R/W	Custom parameter 2 attributes	m3/h	1	32767

Additionally, registers are provided for 2 values with freely configurable display properties.

Register type	Relative Address	Absolute Address	Dir	Name	Unit	Scale	Default value
Holding	1618	41619	R/W	Custom parameter 1 Value	-	check below	32767
Holding	1619	41620	R/W	Custom parameter 2 Value	-	check below	32767

The 'Attributes' register is bitwise interpreted as follows:

**Bit1..0:** scale

00 (0): scale = 1

01 (1): scale = 0.1

10 (2): scale = 0.01

11 (3): scale = 0.001

**Bit 2:** reserved

**Bits 4..3: basic icons enable**

00 (0): none

01 (8) : INDOOR icon

10 (16): SET icon

11 (24): OUTDOOR icon

**Bits 8..5: Units icons enable**

0000 (0) : none

0001 (32) : celcius

0010 (64) : fahrenheit

0011 (96) : %

0100 (128) : %RH

0101 (160) : Pa

0110 (192) : m3/h



0111 (224) : mg/m<sup>3</sup>

1000 (256) : ug/m<sup>3</sup>

1001 (288) : ppm

1010 (320) : ppb

**Bits 11..9: air quality icons**

000 (0): none

001 (512): CO<sub>2</sub>

010 (1024): TVOC

011 (1536): PM<sub>2.5</sub>

100 (2048): PM<sub>10</sub>

**Bit 13..12: Value alignment**

00 (0) : right align;

01 (4096) : center

10 (8192): left align

### 3.13.4 Display Values Configuration

Register type	Relative Address	Absolute Address	Dir	Name	Config Parameter	Unit	Range	Default value
Holding	2600	42601	R/W	Home display parameter	600	enum	see below	1
Holding	2601	42602	R/W	Display values receive timeout	601	min	0-60 mins	5
Holding	2602	42603	R/W	TVOC unit (unit to display for register 1602)	602	enum	0: ug/m <sup>3</sup> 1: mg/m <sup>3</sup> 2: ppm 3: ppb	0

If no updates are received from the master controller for any value for the time defined in 'Display Values Receive Timeout', that value is considered stale and dropped from the list to be displayed, until a fresh value is received again. This function can be disabled by setting the parameter to 0.

'Home Display Parameter' is the display value that the screen returns to when no buttons are touched for a while. It can be selected as follows. If this is set for 'auto-scroll' the screen will automatically scroll between available values every few seconds.

0: auto-scroll

1: Room Temperature

2: Set Temperature

3: Room Humidity

4: Room Air Quality

5: Room CO<sub>2</sub>

6: Pressure

7: Air flow volume

8: Outdoor Temperature

9: Outdoor Humidity  
10: Indoor PM2.5  
11: INDOOR\_PM\_10  
12: Outdoor PM 2.5  
13: Outdoor PM10  
14: Energy in kw  
15: Energy in kwh  
16: Room Number  
17: HVAC Override Status  
18: Reserved1  
19: Reserved2  
20: Reserved3  
21: Reserved4  
22: Custom parameter 1  
23: Custom parameter 2  
24: Reserved5  
25: Reserved6

## TROUBLESHOOTING

The fault condition is displayed on screen along with alarm symbol. Press OK button in ready mode then, up/down buttons to cycle the display between several values.

The fault condition will be displayed as an error code. Refer the troubleshooting table listed below to understand the error codes, it's meaning and action to be performed to resolve the error.

Error Code	Meaning	Action
E01	Onboard sensor fault	Contact Customer care
E02	External sensor fault	Check wiring and replace sensor if faulty
E03	Modbus loss of comms	Check wiring and master controller
E04	Port 2 timeout fault	Check wiring and DALI64 sensor on port 2
E05	Setpoint min/max mismatch	Contact customer care
E06	Fan Speed min/max mismatch	Contact customer care
E07	Lights min/max mismatch	Contact customer care
E08	Blinds min/max mismatch	Contact customer care

**CONFIGURATION PARAMETERS****List of Device configuration parameters**

Config parameter number	Name	Type/ Unit	Range (min-Max)	Default	Notes
0	Firmware Version1	2 bytes	0-255 0-255		Firmware version: major, minor
1	Firmware Version2	2 bytes	0-255 0-255		Firmware version: bug, biult
2	ConfigId	int	0-65535	0	
3	ConfigDateCode	2 bytes	0-65535	0	Configuration date code
4	Modbus slave address	int	1-120	1	Cleaning Mode Timeout
5	Port Baudrate	enum	0: No function 1: Dark Mode 2: Sleep Mode	0	Power Button Function
6	Port1 Parity	enum	0: °C 1: °F	0: °C	Temperature display unit: °C or °F
7	Port1 StopBits	C	0: not allowed 1: allowed	1	Allow temperature unit change on device?
8	Port2 Baudrate	C	0...100%	%100	LCD backlight brightness in percent
9	Port2 Parity	C		0	Resets some settings to default values
10	Port2 StopBits	C	0-9999	0x7FFF	Room Number
11	Port2 Response Timeout				
12	Dali64 sensor slave address	int	0-247	1	0 = No DALI sensor on port 2, no repeater function

Config parameter number	Name	Type/ Unit	Range (min-Max)	Default	Notes
13	External sensor type	enum	"0: NONE 1: NO contact 2: NC contact 3: 0-10 Vdc 4: 2-10 Vdc 5: Raw Ohms 6: NTC10K 7: NTC20K"	0	NO : 0=open, 1 = closed NC : 0= closed, 1 = open
14	On-board sensor temp offset	signed	-10.0 ... +10.0 K	0	
15	On-board humidity sensor offset	signed	-10 ... +10 %Rh	0	
16	Dnd Mur enable	enum	"0: disabled 1: DnD enable 2: MuR enable 3: Dnd/Mur enable"	1	
999	Reset to defaults	bool		0	Resets some settings to default values. Primarily modbus comms settings. Exact list to be compiled later

**Note:** Config from MAster controller details will be available in Master Controller documents.

# List of UI and Access configuration parameters

Config parameter number	Name	Type/ Unit	Range (min-Max)	Default	Notes
100	Room Number	int	0-9999 (or undefined = 0x7FFF)	0x7FFF	
101	LCD Backlight brightness	%	0...100%	100%	
102	Ring brightness	%	0...100%	100%	
103	SLEEP mode ring brightness	%	0...100%	100%	
104	Room temperature display resolution	enum	0: don't display room temp. 1: 1 deg resolution 2: 0.5 deg resolution 3: 0.1 deg resolution	1	
105	Outdoor Temperature display resolution	enum	0: 1 deg resolution 1: 0.5 deg resolution 2: 0.1 deg resolution	2	
106	Temperature unit & user change option		0: °C (user can change) 1: °F (user can change) 2: °C (fixed) 3: °F (fixed)	0	
107	Cleaning Mode Timeout	secs	10-7200 seconds	60 sec	
108	Power Button short press function in READY mode	enum	0: No function 1: Dark Mode 2: Sleep Mode 3: SwitchLightsOnOff Toggle 4: SwitchLightsOn 5: SwitchLightsOff 6: Hello/Goodbye toggle 7: Hello 8: Goodbye	2	Bits 3-8 not implemented yet
109	Power Button long press function in READY mode	enum	same as above	0	Not implemented yet

Config parameter number	Name	Type/ Unit	Range (min-Max)	Default	Notes
110	User access protection	enum	0 free: no restriction, no timeout lock 1 simple: require key combination to unlock 2 secure: require pass-key to unlock 3 no access: display only, no control allowed	0: free	Restrict user access to temperature, lights
111	User access Pin	-	0000...9999	0	Only used if User Access Protection = secure
112	Config menu Pin	-	0000...9999	4663	'HONE' on keypad
113	Timeout to lock status	seconds	0...300 seconds	15 sec	If value is 0, timeout will be disabled.

# List of HVAC Configuration Parameters

Config parameter number	Name	Type/ Unit	Range (min-Max)	Default	Notes
200	Setpoint style	enum	0: absolute 1: relative	0: absolute	
201	Setpoint minimum	signed int (°C / K)	absolute mode: -50....+150 relative mode: -15.....0	absolute: 10 °C relative: -5 K	
202	Setpoint maximum	signed int (°C / K)	absolute mode: -50....+150 relative mode: 0.....15	absolute: 30 °C relative: +5 K	
203	Default Setpoint	°C	10....30 °C	22 °C	
204	Fan type	enum	0: no fan 1: Single speed fan 2: Two-speed fan 3: 3-speed fan 4: EC fan	3	
205	EC Fan speed adjust step size	enum	0: 1% 1 : 2% 2 : 5% 3: 10% 4: 20%	3: 10%	For EC fans only
206	Fan speed low-limit	% or int	0-100 % for EC fans, 0-3 for others	0	
207	Fan speed high limit	% or int	0-100 % 0-3 for others	100	
208	Fan UI attributes	bitmap	Bit 0: Fan override (0: No ovrd, 1: Allow ovrd) Bit 1: Display of 1-stage fan (0: 1 bar, 1: 3 bars) Bit 2-16: reserved	1	If fan override not allowed, disable fan button but keep speed indication & AUTO symbol
209	HvacMode SelectionType	enum	0: disabled 1: simple 2: advanced	0	



Config parameter number	Name	Type/ Unit	Range (min-Max)	Default	Notes
210	AvailableHvacModes	enum	Bit0: "AUTO" Bit1: "HEAT" Bit2: "COOL" Bit3: "FAN" Bit4: "OFF" Bit5: "HTG1" Bit6: "HTG2" Bit7: "CLG1" Bit8: "CLG2"	15	Default : Auto/Heat/Cool/Fan

## List of Lighting Configuration Parameters

Config parameter number	Name	Type/ Unit	Range (min-Max)	Default	Notes
300	Light Group Count	-	0..4	2	
301	Light adjust step size	enum	0: 1% 1: 2% 2: 5% 3: 10% 4: 20%	3	
302	Light Group 1 type	enum	0: on-off / 1: dimmable	1	
303	Light Group 1 min level	%	0..100%	1%	
304	Light Group 1 max level	%	0..100%	100%	
305	Light Group 1 Max Scene No	int	0-16	4	0 = scene selection disabled
306	Light Group 2 type	enum	0: on-off / 1: dimmable	1	
307	Light Group 2 min level	%	0..100%	1%	
308	Light Group 2 max level	%	0..100%	100%	
309	Light Group 2 Max Scene No	int	0-16	4	0 = scene selection disabled
310	Light Group 3 type	enum	0: on-off / 1: dimmable	1	
311	Light Group 3 min level	%	0..100%	1%	

<b>Config parameter number</b>	<b>Name</b>	<b>Type/ Unit</b>	<b>Range (min-Max)</b>	<b>Default</b>	<b>Notes</b>
312	Light Group 3 max level	%	0...100%	100%	
313	Light Group 3 Max Scene No	int	0-16	4	0 = scene selection disabled
314	Light Group 4 type	enum	0: on-off / 1: dimmable	1	
315	Light Group 4 min level	%	0...100%	1%	
316	Light Group 4 max level	%	0...100%	100%	
317	Light Group 4 Max Scene No	int	0-16	4	0 = scene selection disabled

# List of Blinds configuration Parameters

Config parameter number	Name	Type/ Unit	Range (min-Max)	Default	Notes
400	Blind Group Count	int	0..2	1	
401	Blinds position adjust step size	enum	0: 1% 1: 2% 2: 5% 3: 10% 4: 20%	3	
402	Blinds angle adjust step size	enum	0: 1% 1: 2% 2: 5% 3: 10% 4: 15%	3	
403	Blind group 1 type	bitmap	Bit0: angle control (0: position only, 1: position+angle) Bit 1: position direct/ reverse (0: reverse, 1: direct)	1	Direct: up button works 0->100% Reverse: up button works 100->0%
404	Blind 1 position min	%	0..100%	0	
405	Blind 1 position max	%	0..100%	100	
406	Blind 1 angle min	signed int (°)	-180°...180°	-80°	
407	Blind 1 angle max	signed int (°)	-180°...180°	+80°	
408	Blind group 2 type	bitmap	Bit0: angle control (0: position only, 1: position+angle) Bit 1: position direct/ reverse (0: reverse, 1: direct)	1	Direct: up button works 0->100% Reverse: up button works 100->0%
409	Blind 2 position min	%	0..100%	0	
410	Blind 2 position max	%	0..100%	100	
411	Blind 2 angle min	signed int (°)	-180°...180°	-80°	
412	Blind 2 angle max	signed int (°)	-180°...180°	+80°	

# List of Occupancy configuration Parameters

Config parameter number	Name	Type/ Unit	Range (min-Max)	Default	Notes
500	Occupancy Source	enum	0: Modbus only 1: Button only 2: Modbus & override from button	0	0: Modbus only (button disabled) 1: Button only (simple mode, no override, only occupied/ unoccupied switching on WM) 2: Modbus with override from button (advanced mode)
501	Holiday default days	days	1-45	7 days	
502	Bypass default minutes	minutes	10-1440	180 mins	
503	Bypass time adjust step minutes	enum	0: 10 mins 1: 20 mins 2: 30 mins 3: 60 mins	2	
504	Allowed overrides from OFF	bitmap	bit0: unused bit1: unused bit2: Allow override to OCCUPIED bit3: Allow override to OFF bit4: Allow override to HOLIDAY bit5: Allow override to UNOCC bit6: Allow override to STANDBY bit7: Allow override to BYPASS	0	These registers used to define which override are available in which occupancy mode. Short-press is automatically assigned to one of the below, in order of preference: - OCC - UNOCC - BYPASS
505	Allowed overrides from UNOCC	bitmap		144: HOL & BYPASS	
506	Allowed overrides from STANDBY	bitmap		148: OCC, HOL & BYPS	
507	Allowed overrides from OCC	bitmap		176: UNOCC, HOL & BYPS	

Config parameter number	Name	Type/ Unit	Range (min-Max)	Default	Notes
508	Occupancy Auto Reset	bitmap	Bit0: When master mode changes to UNOCC, cancel UNOCC override Bit1: When master mode changes to UNOCC, cancel STBY override Bit2 : When master mode changes to UNOCC, cancel OCC override Bit3: reserved Bit4 When master mode changes to OCC, cancel BYPASS override Bit5: When master mode changes to OCC, cancel OCC override	55 (0x37) (11 1111)	

## List of Display Values configuration parameters

Config parameter number	Name	Type/ Unit	Range (min-Max)	Default	Notes
600	Home display parameter	enum	See below	1	
601	Display Values Receive Timeout	mins	1...60	5	
602	TVOC unit	enum	0: ug/m3 1: mg/m3 2: ppm 3. ppb	2	

Honeywell Building Technologies

1985 Douglas Drive North

Golden Valley, MN 55422

[customer.honeywell.com](http://customer.honeywell.com)

Honeywell Building Control